



Tehnički katalog 2007





TEA - Ambijentalni showroom Peter van Dongen

Kuhinja Tea

Ambijentalni showroom
Peter van Dongen

Petra Preradovića 221, 31000 Đakovo
Tel.: +385 (0)31 840 027
Fax: +385 (0)31 840 026
prodaja@geli.hr

www.geli.hr



TENA



FRONTE: Okvir i uklada izrađeni su od masivnog drva slavanskoga hrasta. Maske ladice se također rade iz masivnog drva slavanskoga hrasta.

POVRŠINSKA OBRADA FRONTI: Svi drveni i furnirani dijelovi fronti premazuju se različitim bojama po izboru kupca iz ponuđenog asortimana, a zatim se lakiraju poliuretanskim lakom u dva sloja. Lak je kvalitete koji je otporan na uvjete u kuhinji.

KORPUS: Korpus je izrađen od troslojne obostrano oplemenjene iverice. Rubovi su zaštićeni melaminskom folijom. Ladice su izrađene od masivnog drva.

OKOV: Spojnice za vrata – šarke su sa novim clip sistemom montaže na pločice. Nosači visećih elemenata su u kombinaciji metalnih i polimernih materijala, podesivi po visini i dubini. Donji elementi pričvršćeni su na nogice od polimernog materijala visine 10 (15) cm uz mogućnost podešavanja po visini. Ručnice standardne za tip proizvoda ili po izboru kupca iz ponuđenog asortimana.

ANA



FRONTE: Okvir vrata je izrađen od masivnog drva slavanskoga hrasta a uklada (ispuna) je iverica debljine 10 mm oplemenjena furnirom slavanskoga hrasta. Maske ladice se također rade iz masivnog drva slavanskoga hrasta.

POVRŠINSKA OBRADA FRONTI: Svi drveni i furnirani dijelovi fronti premazuju se različitim bojama po izboru kupca iz ponuđenog asortimana, a zatim se lakiraju poliuretanskim lakom u dva sloja. Lak je kvalitete koji je otporan na uvjete u kuhinji.

KORPUS: Korpus je izrađen od troslojne obostrano oplemenjene iverice. Rubovi su zaštićeni melaminskom folijom. Ladice su izrađene od masivnog drva.

OKOV: Svi okovi su identični okovu i opisu iz tehničkog opisa programa TENA.

CERTISA



FRONTE: Okvir i uklada izrađeni su od masivnog drva slavanskoga hrasta. Maske ladice se također rade iz masivnog drva slavanskoga hrasta.

POVRŠINSKA OBRADA FRONTI: Svi drveni i furnirani dijelovi fronti premazuju se različitim bojama po izboru kupca iz ponuđenog asortimana, a zatim se lakiraju poliuretanskim lakom u dva sloja. Lak je kvalitete koji je otporan na uvjete u kuhinji.

KORPUS: Korpus je izrađen od troslojne obostrano oplemenjene iverice. Rubovi su zaštićeni melaminskom folijom. Ladice su izrađene od masivnog drva.

OKOV: Svi okovi su identični okovu i opisu iz tehničkog opisa programa TENA.

Tena, Ana, Certisa

- Korpus:** iverica oplemenjena hrast/bijelo 18 mm
iverica oplemenjena hrast/hrast 18 mm (stakleni ormarić)
- Leđa:** lesanit bijeli 3.2 mm
lesanit hrast 3.2 mm (stakleni ormarić)
- Ladice:** drvene, osim na ormariću D-60/metabox, gdje je prva ladica masiv, a ostale dvije metabox sa relingom
- Okov:** šarniri – clip
plastični odbojnici – na sve ormariće i ladičare
- Držači polica:** metalni Ø 5 mm
- Police:** prednji rub kant ABS 0.5 mm, a ostali rubovi kantirani sa melaminskom trakom

MATEJA



FRONTE: Okvir vrata je izrađen od masivnog drva slavanskoga hrasta a uklada (ispuna) je iverica debljine 12 mm oplemenjena furnirom slavanskoga hrasta. Maske ladice se također rade iz masivnog drva slavanskoga hrasta.

POVRŠINSKA OBRADA FRONTI: Svi drveni i furnirani dijelovi fronti premazuju se različitim bojama po izboru kupca iz ponuđenog asortimana, a zatim se lakiraju poliuretanskim lakom u dva sloja. Lak je kvalitete koji je otporan na uvjete u kuhinji.

KORPUS: Korpus je izrađen od troslojne obostrano oplemenjene iverice - hrast/bijela. Rubovi su zaštićeni melaminskom folijom. Ladice su izrađene od masivnog drva. Posebnost Mateje su furnirani elementi, donji (D-20 5 LAD) i gornji (GS-20 1LAD OF)

OKOV: Spojnice za vrata – šarke su sa novim clip sistemom montaže na pločice. Nosači visećih elemenata su u kombinaciji metalnih i polimernih materijala, podesivi po visini i dubini. Donji elementi pričvršćeni su na nogice od polimernog materijala visine 10 (15) cm uz mogućnost podešavanja po visini. Ručnice standardne za tip proizvoda ili po izboru kupca iz ponuđenog asortimana.

KATARINA



FRONTE: Izrađene su iz troslojne iverice oplemenjene mat folijom, rubovi su kantirani ABS trakom debljine 2 mm. Okvir fronti staklenih vrata je aluminijski debljine 19 mm a ispuna je satinirano staklo u osnovnoj izvedbi.

KORPUS: Korpus je izrađen od troslojne obostrano oplemenjene iverice - bukva, trešnja. Korpusi su kantirani melaminskom trakom debljine 0,5 mm.

OKOV: Spojnice za vrata – šarke su sa novim clip sistemom montaže na pločice. Nosači visećih elemenata su u kombinaciji metalnih i polimernih materijala, podesivi po visini i dubini. Donji elementi pričvršćeni su na nogice od polimernog materijala visine 10 (15) cm uz mogućnost podešavanja po visini. Ručnice standardne za tip proizvoda ili po izboru kupca iz ponuđenog asortimana.

ADRIJANA



FRONTE: Izrađene su iz troslojne iverice oplemenjene folijom visokog sjaja, rubovi su kantirani ABS trakom debljine 2 mm. Okvir fronti staklenih vrata je aluminijski debljine 50 mm a ispuna je bojano staklo.

KORPUS: Korpus je izrađen od troslojne obostrano oplemenjene iverice - bukva, trešnja. Korpusi su kantirani melaminskom trakom debljine 0,5 mm.

OKOV: Spojnice za vrata – šarke su sa novim clip sistemom montaže na pločice. Nosači visećih elemenata su u kombinaciji metalnih i polimernih materijala, podesivi po visini i dubini. Donji elementi pričvršćeni su na nogice od polimernog materijala visine 10 (15) cm uz mogućnost podešavanja po visini. Ručnice standardne za tip proizvoda ili po izboru kupca iz ponuđenog asortimana.

KARLA/TEA



FRONTE: Okvir vrata je izrađen od masivnog drva slavanskoga hrasta a uklada je iverica debljine 12 mm oplemenjena furnirom slavanskoga hrasta. Maske ladice se također rade iz masivnog drva slavanskoga hrasta. Ispuna fronti staklenih vrata kod kuhinje Tea je ornament staklo a kod kuhinje Karla zeleni parsol u osnovnoj izvedbi.

POVRŠINSKA OBRADA FRONTI: Svi drveni i furnirani dijelovi fronti premazuju se različitim bojama po izboru kupca iz ponuđenog asortimana, a zatim se lakiraju poliuretanskim lakom u dva sloja. Lak je kvalitete koji je otporan na uvjete u kuhinji.

KORPUS: Opis prema izjavi u prilogu.

OKOV: Spojnice za vrata – šarke su sa novim clip sistemom montaže na pločice. Nosači visećih elemenata su u kombinaciji metalnih i polimernih materijala, podesivi po visini i dubini. Donji elementi pričvršćeni su na nogice od polimernog materijala visine 10 (15) cm uz mogućnost podešavanja po visini. Ladice se izrađuju sa stranicama dvostruke metalne konstrukcije tipa INLINE u boji metalik siva u kombinaciji s podom i leđima od oplemenjene iverice debljine 16 mm. Ručnice standardne za tip proizvoda ili po izboru kupca iz ponuđenog asortimana.

Mateja, Katarina, Adrijana

Korpus:	iverica oplemenjena 18 mm
Leđa:	oplemenjeni lesanit 3.2 mm
Ladice:	metabox
Okov:	šarniri – clip plastični odbojnici – na sve ormariće i ladičare
Držači polica:	metalni Ø 5 mm
Police:	prednji rub kant ABS 0.5 mm

Karla, Tea

Korpus:	iverica oplemenjena vanilija 18 mm rubna traka ABS vanilija 0.5 mm
Leđa:	oplemenjeni lesanit 3.2 mm
Ladice:	Inline
Okov:	šarniri – clip plastični odbojnici – na sve ormariće i ladičare
Držači polica:	metalni Ø 5 mm
Police:	prednji rub kant ABS 0.5 mm, a ostali rubovi kantirani sa melaminskom trakom

EMA



FRONTE: Izrađene su iz furnirane iverice debljine 19, 29 i 39 mm oplemenjene jasenovim furnirom. Rubovi su zaštićeni rubnim furnirom debljine 2 mm. Maske ladica se rade iz masivnog drva jasena.

POVRŠINSKA OBRADA FRONTI: Svi drveni i furnirani dijelovi fronti premazuju se različitim bojama po izboru kupca iz ponuđenog asortimana, a zatim se lakiraju poliuretanskim lakom u dva sloja. Lak je kvalitete koji je otporan na uvjete u kuhinji.

KORPUS: Prema izjavi koja je u prilogu tehničkog opisa.

OKOV: Spojnice – šarniri za vrata su metalni AIRMATIC sa ugrađenim sistemom amortizacije zatvaranja vrata. Ladice se izrađuju sa stranicama dvostruke metalne konstrukcije tipa INLINE u boji metalik siva u kombinaciji s podom i leđima od oplemenjene iverice debljine 16 mm. Nosači visećih elemenata su u kombinaciji metalnih i polimernih materijala, podesivi po visini i dubini. Donji elementi pričvršćeni su na noge od polimernog materijala visine 10 (15) cm uz mogućnost podešavanja po visini. Ručkice standardne za tip proizvoda ili po izboru kupca iz ponuđenog asortimana.

SARA



FRONTE: Okvir vrata je izrađen od masivnog drva jasena a uklada vrata iz MDF ploče debljine 6 mm obostrano furnirano jasenovim furnirom. Maske ladica se rade iz masivnog drva jasena.

POVRŠINSKA OBRADA FRONTI: Svi drveni i furnirani dijelovi fronti premazuju se različitim bojama po izboru kupca iz ponuđenog asortimana, a zatim se lakiraju poliuretanskim lakom u dva sloja. Lak je kvalitete koji je otporan na uvjete u kuhinji.

KORPUS: Prema izjavi koja je u prilogu tehničkog opisa.

OKOV: Svi okovi su identični okovu i opisu iz tehničkog opisa programa EMA.

MIA



FRONTE: Izrađene su iz furnirane iverice debljine 19, 29 i 39 mm oplemenjene furnirom američkog oraha. Rubovi su zaštićeni rubnim furnirom debljine 2 mm. Maske ladica se rade iz masivnog drva američkog oraha.

POVRŠINSKA OBRADA FRONTI: Sve furnirane plohe lakiraju se dva puta poliuretanskim mat lakom.

KORPUS: Prema izjavi koja je u prilogu tehničkog opisa.

OKOV: Svi okovi su identični okovu i opisu iz tehničkog opisa programa EMA.

NINA



FRONTE: Okvir vrata je izrađen od masivnog drva jasena a uklada vrata iz MDF ploče debljine 6 mm obostrano furnirano furnirom američkog oraha. Maske ladica se rade iz masivnog drva američkog oraha.

POVRŠINSKA OBRADA FRONTI: Svi drveni i furnirani dijelovi fronti lakiraju se dva puta poliuretanskim lakom. Svi ostali furnirani dijelovi programa NINA su identični dijelovima iz opisa programa MIA. Staklo (kao ispunja okvira) također se boja komponentama na bazi poliuretana.

KORPUS: Prema izjavi koja je u prilogu tehničkog opisa.

OKOV: Svi okovi su identični okovu i opisu iz tehničkog opisa programa EMA.

EMA, SARA, MIA, NINA

Korpus:	iverica oplemenjena vanilija, bijela 18 mm, rubna traka ABS 0.5 mm
Leđa:	lesonit oplemenjeni 3.2 mm
Ladice:	Inline
Okov:	šarniri Airmatic plastični odbojnici – na sve ormariće i ladičare
Držači polica:	metalni Ø 5 mm
Police:	prednji rub kant ABS 0.5 mm, a ostali rubovi kantirani sa melaminskom trakom

BARBARA



FRONTE: Izrađene su iz MDF ploče obiljepljene PVC folijom u kombinaciji boja vanilija, trešnja i bijela.

KORPUS: Korpus je izrađen od troslojne obostrano oplemenjene iverice - trešnja, vanilija i bijela. Korpusi su kantirani melaminskom trakom debljine 0,5 mm.

OKOV: Spojnice za vrata – šarke su sa novim clip sistemom montaže na pločice. Nosači visećih elemenata su u kombinaciji metalnih i polimernih materijala, podesivi po visini i dubini. Donji elementi pričvršćeni su na nogice od polimernog materijala visine 10 (15) cm uz mogućnost podešavanja po visini. Ručnice standardne za tip proizvoda ili po izboru kupca iz ponuđenog asortimana.

LUCIJA



FRONTE: Vrata kuhinjskog programa LUCIJA se sastoje iz okvirnice i pune uklade ili stakla. Okvirnice su napravljene iz masivnog drva – hrasta, a uklada od MDF ploče debljine 6 mm koja se obostrano furnira hrastovim furnirom. Prednjaci ladice se rade također iz masivnog drva – hrasta.

POVRŠINSKA OBRADA FRONTI: Sve drvene i furnirane dijelove fronti premazuju se različitim bojama po izboru kupca koje su mješavina komponenti na bazi poliuretana, a zatim se lakiraju dva puta poliuretanskim lakom. Staklo (kao ispuna okvira) također se boja komponentama na bazi poliuretana.

KORPUS: Korpus je izrađen od troslojne obostrano oplemenjene iverice - vanilija i bijela. Korpusi su kantirani melaminskom trakom debljine 0,5 mm.

OKOV: Svi okovi su identični okovu i opisu iz tehničkog opisa programa BARBARA.

PETRA



FRONTE: Vrata kuhinjskog programa PETRA sastavljena su iz drvene okvirnice i uklade ili stakla 4 mm. Okvirnice se rade iz masivnog drva – slavonske hrastovine, a uklada od iverice debljine 8 mm koja je profilirana i obostrano furnirana hrastovim furnirom. Prednjaci ladice se rade također iz masivnog drva – hrastovine.

POVRŠINSKA OBRADA FRONTI: Svi drveni i furnirani dijelovi fronti se premazuju različitim bojama po izboru kupca koje su mješavina komponenti na bazi poliuretana, a zatim se lakiraju dva puta poliuretanskim lakom.

KORPUS: Korpus je identičan opisu iz programa LUCIJA.

OKOV: Spojnice – šarniri za vrata su metalni AIRMATIC sa ugrađenim sistemom amortizacije zatvaranja vrata. Ladice se izrađuju sa stranicama dvostruke metalne konstrukcije tipa INLINE u boji metalik siva u kombinaciji s podom i leđima od oplemenjene iverice debljine 16 mm. Nosači visećih elemenata su u kombinaciji metalnih i polimernih materijala, podesivi po visini i dubini. Donji elementi pričvršćeni su na nogice od polimernog materijala visine 10 (15) cm uz mogućnost podešavanja po visini. Ručnice standardne za tip proizvoda ili po izboru kupca iz ponuđenog asortimana.

Barbara, Lucija, Petra

- Korpus:** iverica oplemenjena 18 mm, rubna traka ABS 0.5 mm
Leđa: lesanit oplemenjeni 3.2 mm
Ladice: Inline
Okov: šarniri Airmatic, plastični odbojnici – na sve ormarice i ladičare
Držači polica: metalni Ø 5 mm
Police: prednji rub kant ABS 0.5 mm, a ostali rubovi kantirani sa melaminskom trakom

DOMINOO



FRONTE: Vrata kuhinjskog programa DOMINOO se sastoje iz okvirnice i pune uklade ili stakla. Okvirnice su napravljene iz kvalitetnog punog drva – hrast, a uklada je također puno drvo hrast. Prednjaci ladice se rade također iz punog drva – hrast.

POVRŠINSKA OBRADA FRONTI: Svi drveni i furnirani dijelovi fronti lakiraju se dva puta poliuretanskim lakom.

- Korpus:** Masivno drvo hrasta u kombinaciji s furniranom ivericom 19 mm, poprečni dijelovi također iz furnirane iverice kantirani rubnim furnirom 2mm
Leđa: Ploča vlaknatica oplemenjena furnirom
Ladice: Delux
Okov: šarniri – clip
 plastični odbojnici - na sve ormarice i ladičare
Držači polica: metalni Ø 5 mm
Police: prednji rub kantiran furnirom hrasta

PREDNOSTI



ŠARNIRI

1. Kod standardnih rješenja šarki kut otvaranja je 110 stupnjeva, što je kod drugih 95 ili 100 stupnjeva
2. Montaža tj. demontaža na korpus je vrlo jednostavna, što omogućava Snap-on/clip tehniku
3. Lončić je potpuno zatvoren
4. Spojnica je u potpunosti metalna, nema nikakvih plastičnih dijelova
5. Podešavanje po visini vrši se kroz tijelo šarke, što samu podložnu pločicu čini estetski lijepom
6. Što se kvalitete tiče, sve šarke imaju certifikate i servis nam je dostupan u svakom trenutku.



LADICE

1. Ladice su nosivosti 40 kg i 70 kg, potpuno izvlačenje
2. Visine ladica su: 63 mm i 90 mm, a dužine od 250 do 600 mm, boja metalic
3. Sistemi relinga dostupni su kao okrugli i četvrtasti, te prate sve dužine i boje ladica.
4. Fronta ladice vrlo se jednostavno montira tj. demontira bez alata, radi čišćenja unutrašnjosti ladice
5. Maksimalno je iskorištena unutrašnja širina ladice, budući su stranice ravne, a ne nakošene kao kod drugih rješenja
6. Stjenke ladica su dvostruke, čime se povećava čvrstoća čitavog tijela ladice
7. Gibanje se vrši kretanjem preko zupčaste lajsne što čini kretanje ladice ravnomjerno
8. Montaža je vrlo jednostavna, nisu potrebni vijci
9. Atestirane su na 100.000 otvaranja
10. Što se kvalitete tiče, sve ladice imaju certifikate i servis nam je dostupan u svakom trenutku.



UPUTE ZA NARUČIVANJE

Kod naručivanja kuhinja molimo da navedete:

- naziv kuhinje
- boju fronti
- boju korpusa
- naziv radne ploče
- visinu i vrstu podne maske
- tip ugradbenog hladnjaka i visine vrata
- naziv ručkica ukoliko nije standardna
- opciono izradu tijesnog spoja radnih ploča

NAPOMENE

- cijene u katalogu su izražene u bodovima
1 bod = 1,00 kn bez PDV-a
- proizvođač zadržava pravo promjene vrijednosti boda

I GRUPA KUHINJA (TENA, ANA, CERTISA)

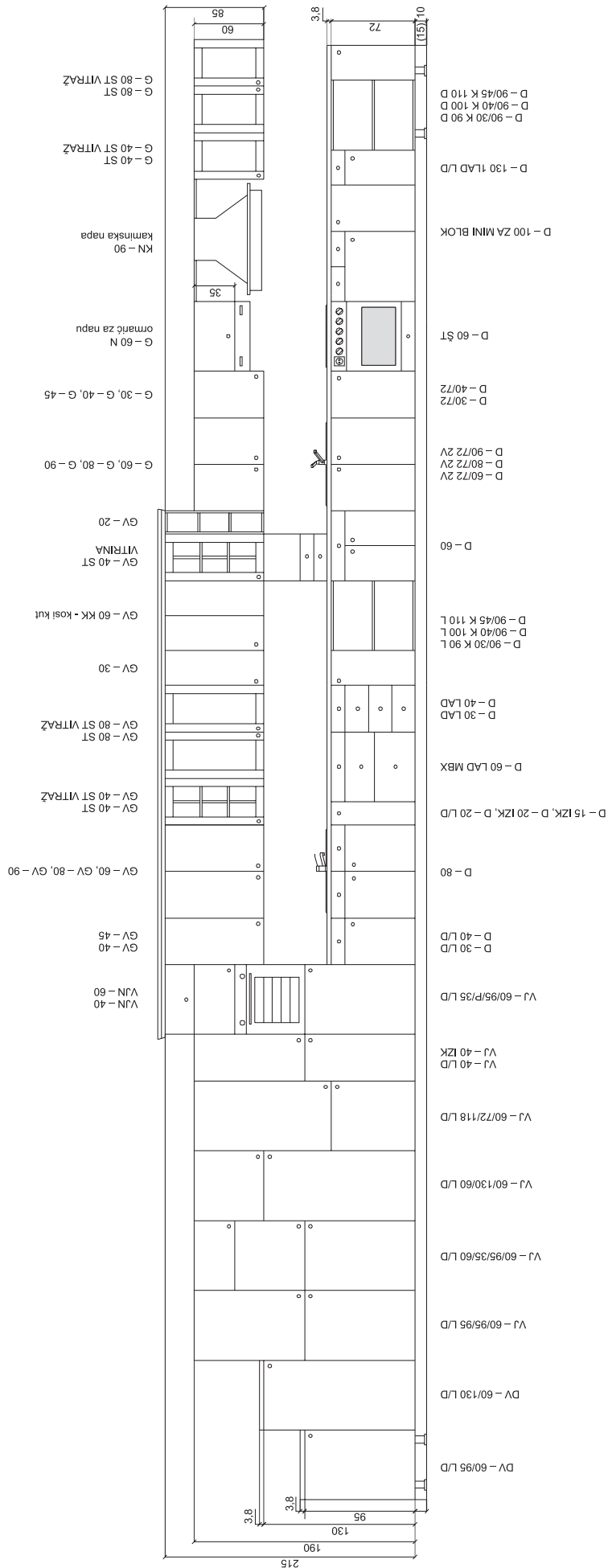

OSNOVNE ŠIRINE I VISINE KUHINJSKIH ELEMENATA

II GRUPA KUHINJA

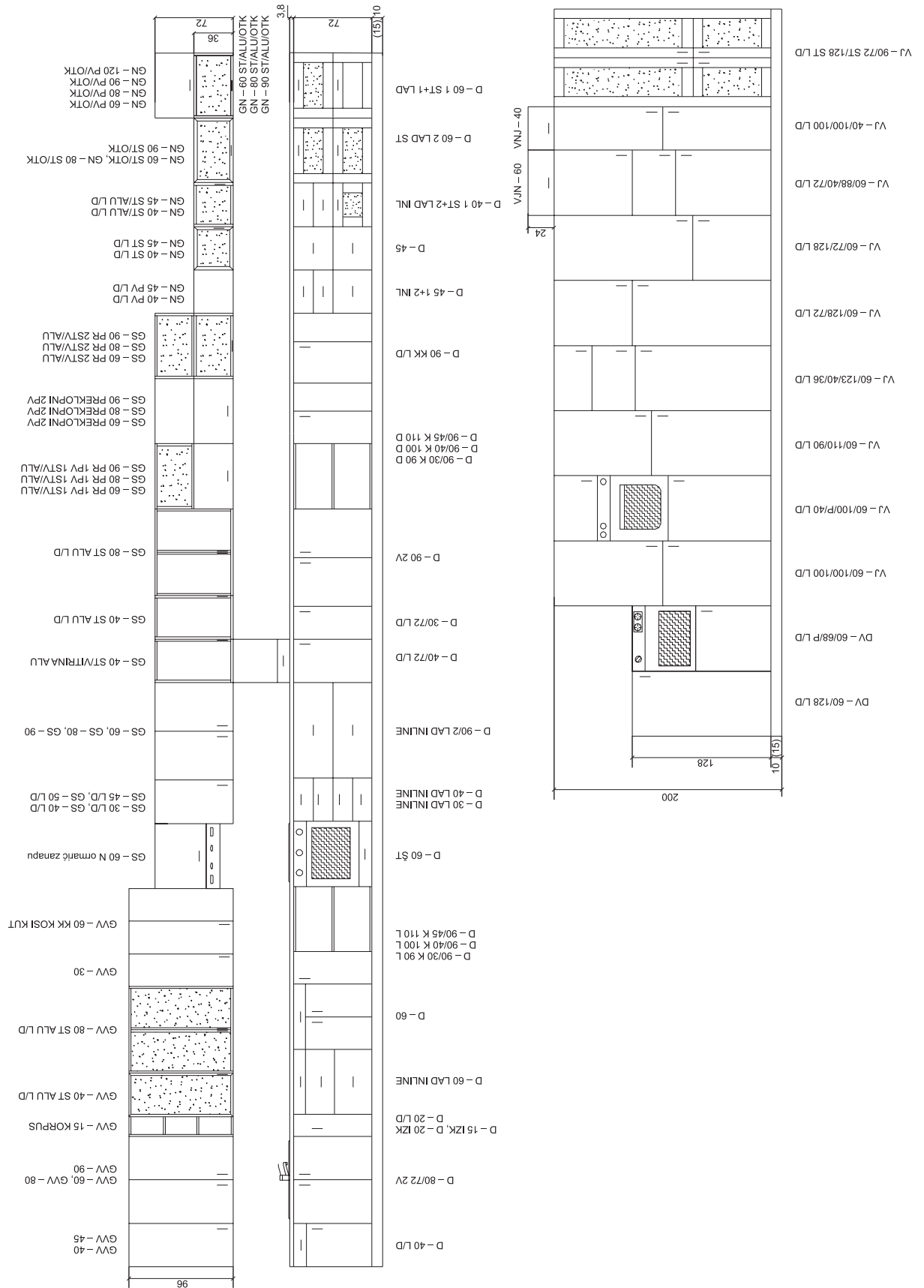

III GRUPA KUHINJA - DOMINOO

GS - 139/89 ST/ZV OTK		D - 139 ZLAD		VJ - 69/36-LAD/P/MW/36 za pećnicu i mikrovlnu pećnicu	
GS - 139 L/D		D - 139 SLAD (2+1+2)		VJ - 69/124/36	
GS - 89 ST/L/D		D - 89 ZLAD		VJ - 69/124/72	
GS - 74 ST/L/D		D - 74 LAD 1+2		VJ - 69/PP/90.4/36 omara za ugradnju perlice	
GS - 69 ST/L/D		D - 69 ZLAD		VJ - 69/ZLAD/P/60	
GS - 60 L/D		D - 69 ST LAD			
GS - 49 ST/L/D		D - 49 LAD 1+2			
GN - 139 OTK		D - 139 ZV			
GN - 89 OTK		D - 89 ZV			
GN - 74 OTK		D - 74 L/D			
GN - 69 OTK		D - 69 L/D			
GN - 49 OTK		D - 49 L/D			

PRIKAZ ŠANKA

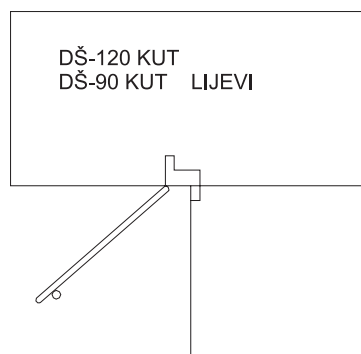
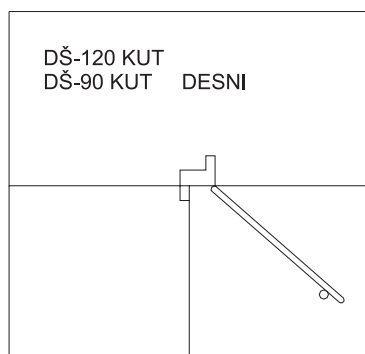
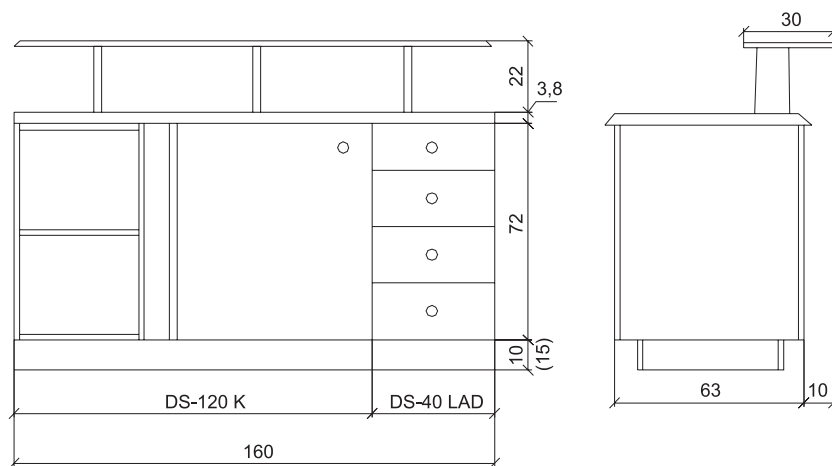

PRIKAZ POSTAVLJANJA GUL-a I DUL-a

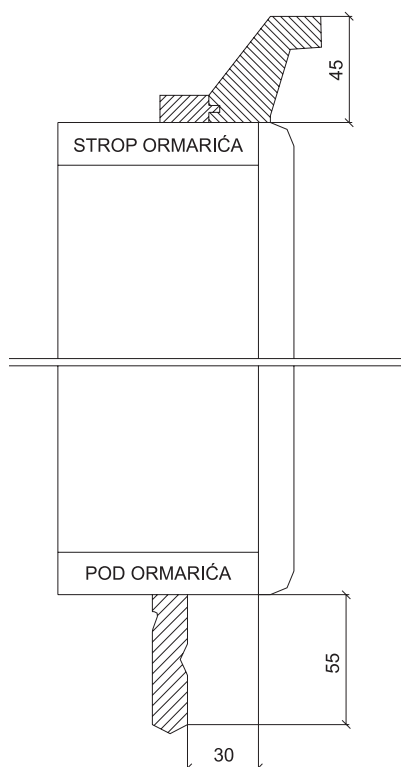

PRIKAZ KUTA

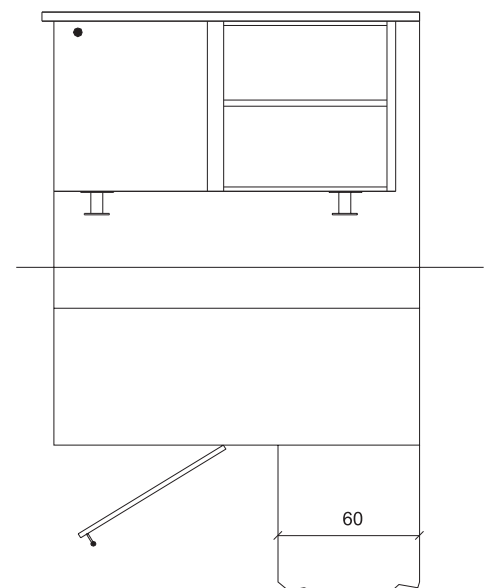

D-90/30 - KUT = ZP = 90cm

D-90/40 - KUT = ZP = 100cm

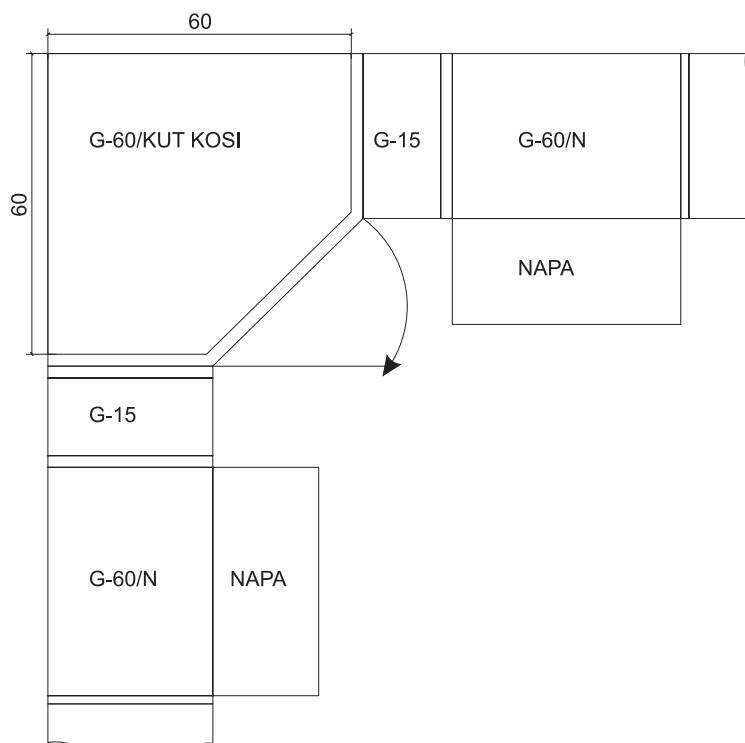

D-90/45 - KUT = ZP = 105cm

PRIKAZ MONTAŽE NAPE KOD KUTA

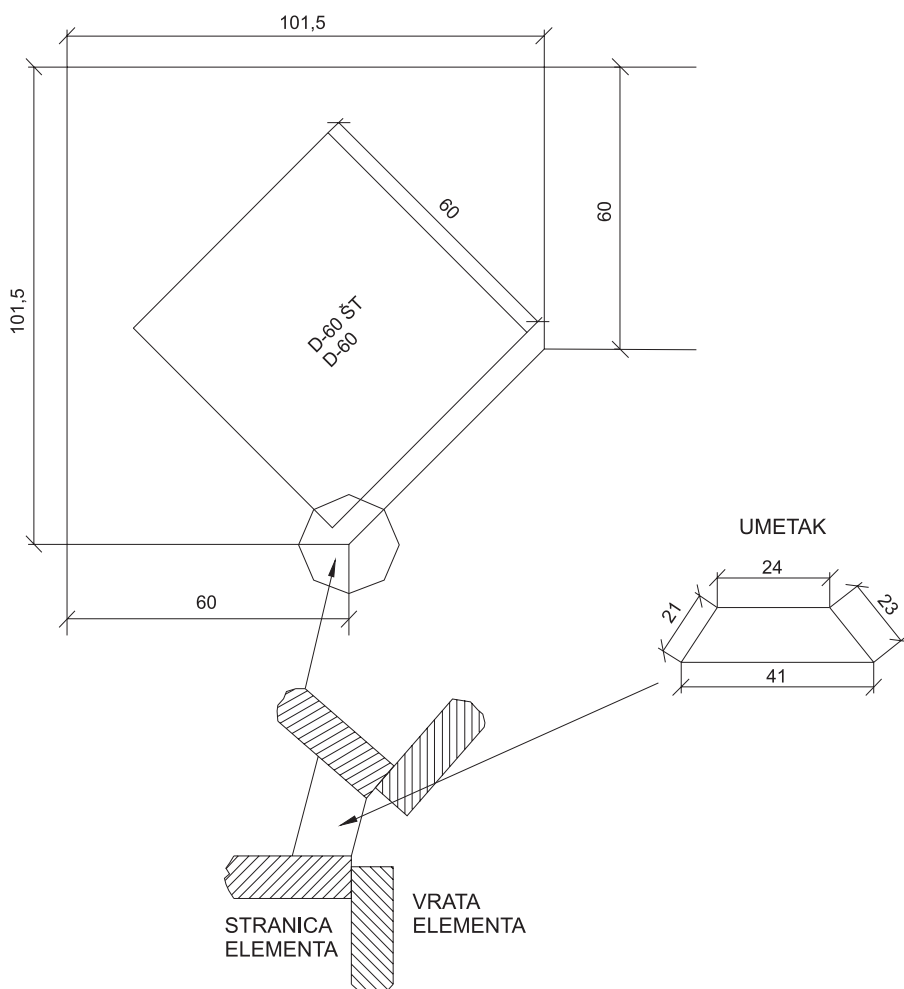

UGRADNJA ŠTEDNJAKA U KOSI KUT

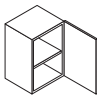

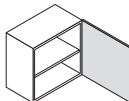
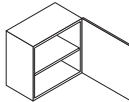
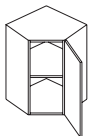
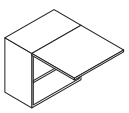
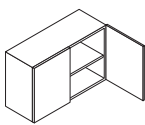
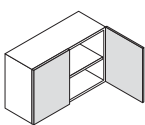
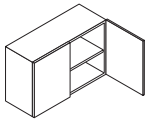
ELEMENTI	OPIS	MJERE	TENA	ANA N	CERTISA
	G-30 L/D 1 x vrata 1 x polica	60x30x35	537,-	484,-	563,-
	G-35-Z/ST/HR L/D G-35-Z/ST/B VŽ L/D 1 x staklena vrata 1 x polica	60x35x35 60x35x35	701,- 1.274,-	630,-	736,- 1.338,-
	G-40-ST/B L/D G-40-ST/B VŽ L/D G-40-ST/HR L/D 1 x staklena vrata 1 x polica	60x40x35 60x40x35 60x40x35	547,- 998,- 596,-	492,-	574,- 1.047,- 626,-
	G-40 L/D G-45 L/D 1 x vrata 1 x polica	60x40x35 60x45x35	596,- 615,-	537,- 553,-	626,- 646,-
	G-60-KK L/D 1 x vrata 1 x polica	60x60x60	845,-	760,-	887,-
	G-60-N za napu 1 x vrata podizna	35x60x35	957,-	861,-	1.004,-
	G-60 2V 2 x vrata 1 x polica	60x60x35	986,-	887,-	1.035,-
	G-80-ST/B 2V G-80-ST/B VŽ 2V G-80-ST/HR 2V 2 x staklena vrata 1 x polica	60x80x35 60x80x36 60x80x35	919,- 1.834,- 985,-	827,-	965,- 1.925,- 965,-
	G-80 2V G-90 2V 2 x vrata 1 x polica	60x80x35 60x90x35	1.053,- 1.088,-	947,- 980,-	1.106,- 1.143,-

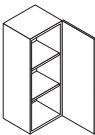
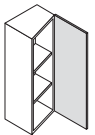
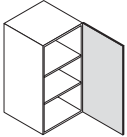
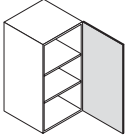
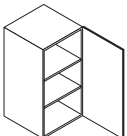
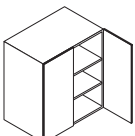
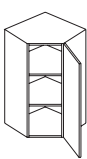
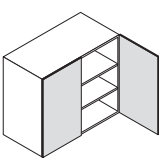
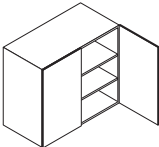

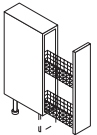
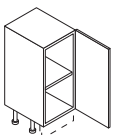
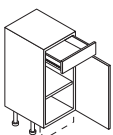
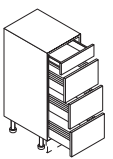
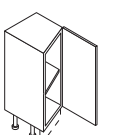
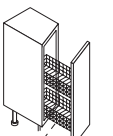
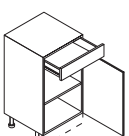
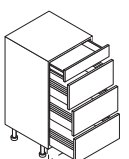
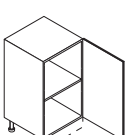
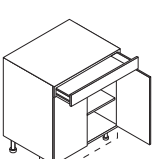
ELEMENTI	OPIS	MJERE	TENA	ANA N	CERTISA
	GV-30 L/D 1 x vrata 2 x polica	85x30x35	648,-	583,-	681,-
	GV-35-Z/ST L/D GV-35-Z/HR VŽ L/D 1 x staklena vrata 2 x polica	85x35x35 85x35x35	930,- 1.690,-	837,- 1.469,-	977,- 1.775,-
	GV-40-ST/B L/D GV-40-ST/B VŽ L/D 1 x staklena vrata 2 x polica	85x40x35 85x40x35	701,- 1.264,-	630,- 1.137,-	736,- 1.328,-
	GV-40-ST/HR L/D GV-40-ST/VIT/HR L/D 1 x staklena vrata 2 x polica	85x40x35 85x40x35	701,- 1.014,-	630,- 913,-	736,- 1.065,-
	GV-40 L/D GV-45 L/D 1 x vrata 2 x polica	85x40x35 85x45x35	722,- 727,-	649,- 655,-	758,- 765,-
	GV-60 2V 2 x vrata 2 x polica	85x60x35	1.207,-	1.086,-	1.267,-
	GV-60-KK L/D 1 x vrata 2 x polica	85x60x60	1.004,-	903,-	1.055,-
	GV-80-ST/B GV-80-ST/B VŽ GV-80-ST/HR 2 x staklena vrata 2 x polica	85x80x35 85x80x35 85x80x35	1.150,- 2.277,- 1.150,-	1.035,- 2.049,- 1.035,-	1.207,- 2.391,- 1.208,-
	GV-80 2V GV-90 2V 2 x vrata 2 x polica	85x80x35 85x90x35	1.311,- 1.364,-	1.180,- 1.228,-	1.377,- 1.432,-

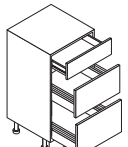
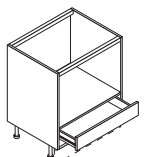
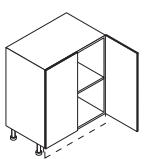
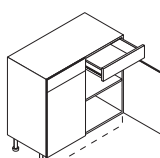
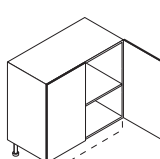
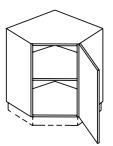
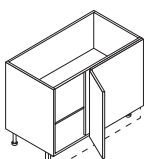
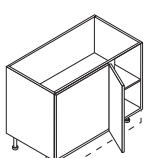
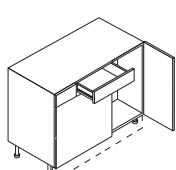

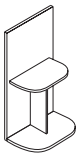
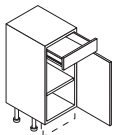
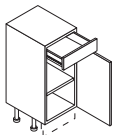
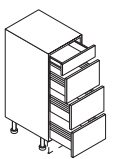
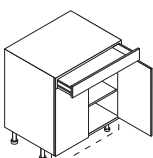
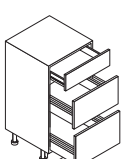
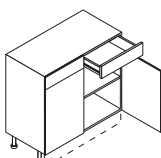
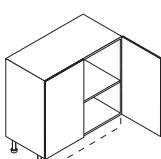
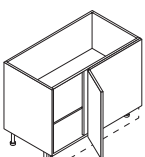
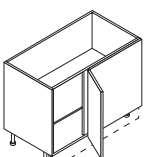
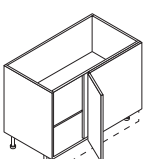
ELEMENTI	OPIS	MJERE	TENA	ANA N	CERTISA
	D-15-MBX IZK	82x15x58	911,-	851,-	1.042,-
	D-20-MBX IZK	82x20x58	1.137,-	1.088,-	1.173,-
	D-20/72 L/D	82x20x58	697,-	627,-	680,-
	D-30/72 L/D	82x30x58	745,-	670,-	727,-
	D-30 L/D 1LAD	82x30x58	854,-	768,-	897,-
	1 x vrata/60 1 x ladica 1 x polica				
	D-30-LAD	82x30x58	1.357,-	1.222,-	1.426,-
	1 x ladica plitka 3 x ladica duboka				
	D-35-Z L/D	82x35x58	1.086,-	977,-	1.140,-
	1 x vrata 1 x polica				
	D-35-Z-IZK L/D	82x35x58	2.659,-	2.393,-	2.792,-
	1 x vrata 1 x izvlačna košara				
	D-40 L/D 1LAD	82x40x58	1.022,-	920,-	1.073,-
	1 x vrata/60 1 x ladica 1 x polica				
	D-40-LAD	82x40x58	1.503,-	1.352,-	1.579,-
	1 x ladica plitka 3 x ladica duboka				
	D-40/72 L/D	82x40x58	770,-	693,-	809,-
	D-45/72 L/D	82x45x58	815,-	737,-	856,-
	D-60/72 L/D	82x60x58	1.262,-	1.135,-	1.324,-
	1 x vrata/72 1 x polica				
	D-60 2V 1LAD	82x60x58	1.416,-	1.274,-	1.486,-
	2 x vrata 1 x ladica 1 x polica				

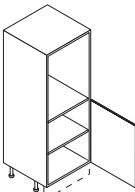
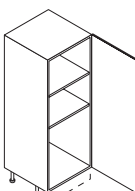
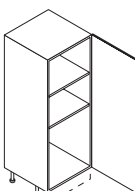
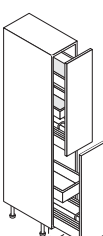
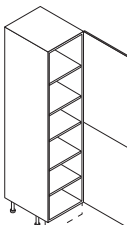
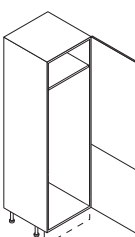
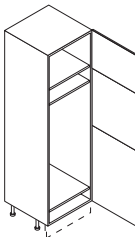

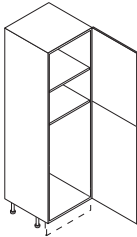
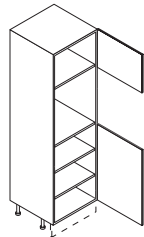
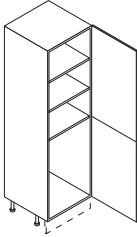
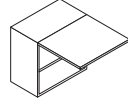
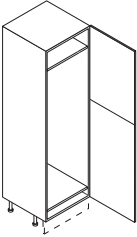
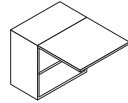

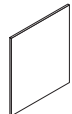

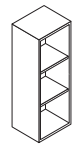
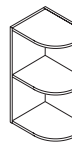
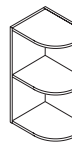
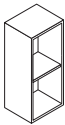

ELEMENTI	OPIS	MJERE	TENA	ANA N	CERTISA
	D-60-LAD/MBX	82x60x58	2.059,-	1.854,-	2.163,-
	1 x ladica plitka 1 x ladica 25 cm 1 x ladica 35 cm				
	D-60 ŠT	82x60x58	761,-	685,-	799,-
	1 x ladica mbx				
	D-60/72-2V	82x60x58	1.306,-	1.175,-	1.371,-
	2 x vrata/72 1 x polica				
	D-80 2V 2LAD	82x80x58	1.771,-	1.594,-	1.860,-
	2 x vrata 2 x ladica 1 x polica				
	D-80/72-2V	82x80x58	1.438,-	1.294,-	1.509,-
	D-90/72-2V	82x80x58	1.485,-	1.337,-	1.560,-
	2 x vrata/72 1 x polica				
	D-90-KK L/D	82x90x90	1.334,-	1.201,-	1.401,-
	1 x vrata 1 x polica				
	D-90/30-K-90 L	82x90x58	1.117,-	1.005,-	1.173,-
	D-90/40-K-100 L	82x90x58	1.148,-	1.034,-	1.206,-
	D-90/45-K-105 L	82x90x58	1.162,-	1.045,-	1.220,-
	1 x vrata/72 1 x polica				
	D-90/30-K-90 D	82x90x58	1.117,-	1.005,-	1.173,-
	D-90/40-K-100 D	82x90x58	1.148,-	1.034,-	1.206,-
	D-90/45-K-105 D	82x90x58	1.162,-	1.045,-	1.220,-
	1 x vrata/72 1 x polica				
	D-100-MB 2V L/D	82x100x58	1.978,-	1.780,-	2.077,-
	1 x maska 30 cm 1 x vrata 40cm 1 x vrata 60cm 1 x ladica 30cm				

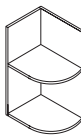

ELEMENTI	OPIS	MJERE	TENA	ANA N	CERTISA
	DŠ-30-Z	82x56x30	948,-	854,-	-
	DŠ-30 L/D 1LAD	82x30x60	1.206,-	1.085,-	1.266,-
	DŠ-40 L/D 1LAD	82x40x60	1.487,-	1.339,-	1.562,-
	1 x vrata 60cm 1 x vrata 72cm 1 x ladica 1 x polica				
	DŠ-40-LAD	82x40x60	1.969,-	1.772,-	2.068,-
	1 x ladica/plitka 3 x ladica/duboka 4 x maska 1 x vrata				
	DŠ-60 2V 1LAD	82x60x60	1.944,-	1.925,-	2.245,-
	2 x vrata 60x30 1 x ladica 1 x vrata 60x72				
	DŠ-60-LAD/MBX	82x60x60	2.783,-	-	-
	1 x vrata 60x72 1 x ladica plitka 1 x ladica 25 cm 1 x ladica 35 cm				
	DŠ-80 2V 2LAD	82x80x60	2.704,-	2.433,-	2.839,-
	2 x vrata 60x40 2 x ladica 1 x polica 2 x vrata 72x40				
	DŠ-90 2V	82x90x60	2.488,-	-	-
	4 x vrata 45cm 1 x polica				
	DŠ-90/30-K L/D		2.728,-	2.232,-	2.864,-
	DŠ-90/45-K L/D		2.165,-	-	-
	DŠ-120-K L/D	82x120x60	2.728,-	2.455,-	2.864,-
	1 x vrata 72x60 1 x polica 3 x vrata 72x40				

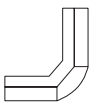
ELEMENTI	OPIS	MJERE	TENA	ANA N	CERTISA
	DV-60/72/P	134x60x58	1.663,-	1.500,-	1.744,-
	1 x vrata 72 1 x polica				
	DV-60/130-HL L/D	140x60x58	1.872,-	1.685,-	1.966,-
	DV-60/95-HL L/D	105x60x58	1.575,-	1.418,-	1.653,-
	1 x vrata 2 x police				
	VJ-40-IZK	200x40x58	7.244,-	6.520,-	7.605,-
	2 x vrata 95 2 x izvl. košara				
	VJ-40 L/D	200x40x58	1.755,-	1.580,-	1.841,-
	2 x vrata 95 4 x polica				
	VJ-60/72/118 L/D	200x60x58	2.531,-	2.278,-	2.658,-
	1 x vrata 72 cm 1 x vrata 118cm 1 x pregrada				
	VJ-60/95/60/35 L/D	200x60x58	2.742,-	2.468,-	2.880,-
	1 x vrata 95 cm 1 x vrata 60 cm 1 x vrata 35cm 3 x pregrada				

ELEMENTI	OPIS	MJERE	TENA	ANA N	CERTISA	ELEMENTI	OPIS	MJERE	TENA	ANA N	CERTISA
	VJ-60/130/60 HL L/D 1 x vrata 130cm 1 x vrata 60 cm 1 x polica	200X60X58	2.531,-	2.278,-	2.658,-		VJ-60/95/P/35 L/D 1 x vrata 95cm 1 x p-60 1 x vrata 35cm 2 x polica	200x60x58	2.329,-	2.096,-	2.445,-
	VJ-60/95/95 L/D 2 x vrata 95 2 x polica	200x60x58	2.531,-	2.278,-	2.542,-		VJN-40 1 x vrata	25x40x58	457,-	411,-	480,-
	VJ-60/130/60 L/D 1 x vrata 130cm 1 x vrata 60cm 2 x pregrada	200x60x58	2.742,-	2.468,-	-		VJN-60 1 x vrata	25x60x58	538,-	484,-	564,-
							VTA 45X60-PS VTA 45X72-PS		374,- 397,-	337,- 358,-	393,- 418,-
							VTA 60X60-PS VTA 60X72-PS		418,- 491,-	376,- 442,-	440,- 515,-

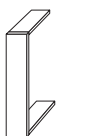





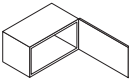
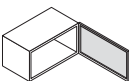
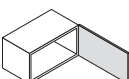

ELEMENTI	OPIS	MJERE	JM	TENA	ANA N	CERTISA	ELEMENTI	OPIS	MJERE	JM	TENA	ANA N	CERTISA
	MASKA Zavr. letvica							GV-15	85x15x33	kom	318,-	318,-	318,-
	Furnir hrast	60x10x1.9	kom	92,-	92,-	92,-		GV-20	85x20x33	kom	351,-	351,-	351,-
	Furnir hrast	72x10x1.9	kom	111,-	111,-	111,-		2 x polica					
	Furnir hrast	85x10x1.9	kom	131,-	131,-	131,-							
	Furnir hrast	96x10x1.9	kom	149,-	149,-	149,-							
	Oplemenjeno folijom	60x10x1.9	kom	48,-	48,-	48,-							
	Oplemenjeno folijom	72x10x1.9	kom	57,-	57,-	57,-		G-30-Z L/D	60x30x33	kom	326,-	326,-	326,-
	Oplemenjeno folijom	85x10x1.9	kom	66,-	66,-	66,-		G-30 - ZF L/D	60x30x33	kom	482,-	482,-	482,-
	Oplemenjeno folijom	96x10x1.9	kom	75,-	75,-	75,-							
	Korpus G-15	60x15x33	kom	263,-	263,-	263,-		GV-30-Z L/D	85x30x33	kom	458,-	458,-	458,-
	Korpus G-20	60x20x33	kom	276,-	276,-	276,-		GV-30 - ZF L/D	85x30x33	kom	639,-	639,-	639,-
	1 x polica												

ELEMENTI	OPIS	MJERE	JM	TENA	ANA N	CERTISA
	D-30-Z L/D	82x30x58	kom	474,-	474,-	474,-
	D-30ZF L/D	82x30x58	kom	662,-	662,-	662,-
	KAMIN NAPA-90 aspirator SP 330x25x900	70x90x50	kom	2.980,-	2.980,-	2.980,-
	UP-30-Z D/L ukrasna polica završna	25x30x32	kom	322,-	322,-	322,-
	UP-30	25x30x32	kom	283,-	283,-	283,-
	UP-40	25x40x32	kom	297,-	297,-	297,-
	UP-45	25x45x32	kom	314,-	314,-	314,-
	UP-60	25x60x32	kom	347,-	347,-	347,-
	UP-80	25x80x32	kom	380,-	380,-	380,-
	UP-60-K/ K	25x60x60	kom	471,-	471,-	471,-
	GUL-30-Z L/D hrast gornja ukrasna letva	38x33	kom	112,-	112,-	112,-
	GUL-120 hrast masiv		kom	116,-	116,-	116,-
	GUL-230 hrast masiv		kom	234,-	234,-	234,-
	DUL-30-Z L/D hrast donja ukrasna letva	28x30	kom	112,-	112,-	112,-
	DUL-120 hrast masiv		kom	116,-	116,-	116,-
	DUL-230 hrast masiv		kom	234,-	234,-	234,-
	KORPUS ZAVRŠNE MASKE G, GV / GS, GVV		kom	69,-	69,-	69,-

ELEMENTI	OPIS	MJERE	JM	TENA	ANA N	CERTISA
	PODNA MASKA D-30/Z					
	zavr. furnirana hr. 30cm	30x10	kom	146,-	146,-	146,-
	zavr. oplemenjena 30cm	30x10	kom	62,-	62,-	62,-
	zavr. furnirana hr. 30cm	30x15	kom	215,-	215,-	215,-
	zavr. oplemenjena 30cm	30x15	kom	91,-	91,-	91,-
	POD. MASKA D-35/ZV 10,15					
	zavr. furnirana hr. 35cm	35x15	kom	215,-	215,-	215,-
	zavr. furnirana hr. 35cm	35x10	kom	146,-	146,-	146,-
	zavr. front. opl. folijom	35x15	kom	120,-	120,-	120,-
	zavr. front. opl. folijom	35x10	kom	81,-	81,-	81,-
	zavr. korpus. opl. folijom	35x15	kom	96,-	96,-	96,-
	zavr. korpus. opl. folijom	35x10	kom	65,-	65,-	65,-
	PM - PODNA MASKA 10,15x135, 270					
	opl. frontalna iverica	135x10	kom	44,-	44,-	44,-
	opl. frontalna iverica	135x15	kom	65,-	65,-	65,-
	opl. korpusna iverica	270x10	kom	63,-	63,-	63,-
	opl. korpusna iverica	270x15	kom	95,-	95,-	95,-

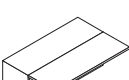
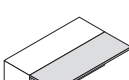
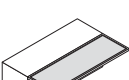
LEGENDA

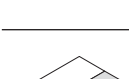
G	- gornji element	VŽ	- vitraž
GN	- gornji niski element	KK	- kosi kut
GS	- gornji srednji elem.	K	- kut
GV/GVV	- gornji visoki elem.	P	- za pećnicu
D	- donji element	MW	- za mikrov. pećnicu
DŠ	- donji elem. za šank	HL	- za hladnjak
DV	- donji visoki elem.	B	- bijelo
JV	- visoka jedinica	OF	- otvoreni furnirani
VJN	- nastavak za vis. jed.	N	- element za napu
ŠT	- elem. za štednjak	MBX	- metabox
L/D	- vrata lijevo/desno	INL	- inline
LAD	- ladičar/ladica	DLX	- deluxe
ULAD	- U ladičar	UP	- ukrasna polica
PV	- puna vrata	PM	- podna maska
LV	- leptir vrata	GUL	- gornja ukrasna letva
ST/STV	- staklena vrata	DUL	- donja ukrasna letva
V/VTA	- vrata	PS	- perilica za suđe
OKR	- okretna vrata	RLH	- rubna letva hrast
PR	- preklapna vrata	RL ALU	- rubna letva aluminij
ALU	- alu	ZP	- zajednička ploča
OTK	- otklopna vrata	ZPŠ	- zajednička ploča šanka
Z	- završni element	PF	- postforming
ZF	- završni furnirani	ZPPF	- zajednička ploča postforming
IZK	- izvlačna košara	ZPOŠ	- zaobljena ploča šanka
MB	- mini blok		
HR	- hrast		
VIT	- vitrina		

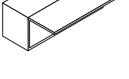
ELEMENTI	OPIS	MJERE	MATEJA	KATARINA	ADRIJANA	KARLA	TEA	EMA	SARA	MIA	NINA	BARBARA	LUCIJA	PETRA
	GN-40-PV L/D	36x40x35		466,-				526,-	660,-	634,-	919,-	551,-	660,-	660,-
	GN-45-PV L/D	36x45x35		491,-				537,-	682,-	655,-	958,-	581,-	682,-	682,-
	GN-40-ST/ALU L/D	36x40x35		677,-										
	GN-45-ST/ALU L/D	36x45x35		788,-										
	GN-40-ST L/D	36x40x35							825,-		975,-	606,-	825,-	825,-
	GN-45-ST L/D	36x45x35							891,-		1.016,-	639,-	891,-	891,-
	GN-60-PV/OTK	36x60x35		741,-	790,-			809,-	1.260,-	988,-	1.617,-	878,-	1.260,-	1.260,-
	GN-60-ST/OTK	36x60x35							1.339,-		1.718,-	855,-	1.339,-	1.339,-
	GN-60-ST/ALU/OTK	36x60x35		1.087,-	1.119,-									
	GN-80-PV/OTK	36x80x35		778,-	808,-			1.092,-	1.387,-	1.298,-	1.792,-	722,-	1.387,-	1.387,-
	GN-90-PV/OTK	36x90x35		798,-	838,-			1.142,-	1.450,-	1.367,-	1.873,-	777,-	1.450,-	1.450,-
	GN-80-ST/OTK	36x80x35							1.469,-		1.899,-	994,-	1.469,-	1.469,-
	GN-90-ST/OTK	36x90x35							1.537,-		1.986,-	1.043,-	1.537,-	1.537,-
	GN-80-ST/ALU/OTK	36x80x35		1.232,-	1.373,-									
	GN-90-ST/ALU/OTK	36x90x35		1.290,-	1.434,-									
	GN-90-PV/OTK/LIGHT	36x90x35						2.410,-		2.885,-				
	GN-90-ST/OTK/LIGHT	36x90x35							3.210,-	3.114,-	3.707,-		3.210,-	3.210,-
	GN-120-PV/OTK	36x120x35						1.291,-	1.640,-	1.545,-	2.119,-		1.640,-	1.640,-
	GN-120-ST/OTK	36x120x35							1.738,-		2.245,-		1.738,-	1.738,-

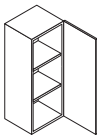
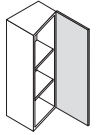
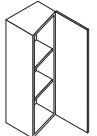
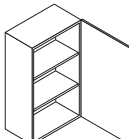
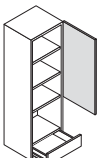
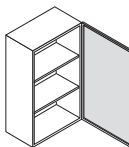
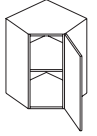
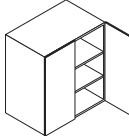
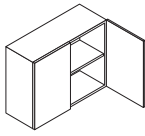
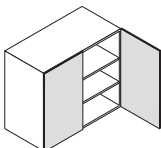
ELEMENTI	OPIS	MJERE	MATEJA	KATARINA	ADRIJANA	KARLA	TEA	EMA	SARA	MIA	NINA	BARBARA	LUCIJA	PETRA
	GS-30 L/D 1 x vrata 2 x polica	72x30x35	505,-	383,-	424,-	710,-	581,-	670,-	831,-	798,-	1.025,-	426,-	831,-	831,-
	GS-35-Z/ST/HR L/D G-35-Z/ST L/D 1 x vrata 2 x polica	72x35x35 72x35x35	659,-			980,-	980,-		1.401,-		1.467,-	762,-	1.401,-	1.401,-
	GS-35-Z/PV L/D 1 x vrata 2 x polica	72x35x35		833,-	920,-									
	GS-40 L/D GS-45 L/D GS-50 L/D GS-60 L/D 1 x vrata 2 x polica	72x40x35 72x45x35 72x50x35 72x45x35	561,- 578,- 684,-	419,- 440,- 476,-	468,- 495,- 534,-	759,- 798,-	644,- 664,-	730,- 762,-	921,- 950,-	896,- 922,-	1.113,- 1.164,-	516,- 613,-	921,- 888,-	921,- 888,-
	GS-40-ST/VIT/B L/D GS-40-ST/VIT/ALU L/D 1 x vrata 1 x ladica 2 x polica	124x40x35 124x40x35	1.221,-											
	GS-40-ST/HR L/D GS-40-ST/ALU L/D GS-40-ST L/D GS-45-ST L/D GS-60-ST L/D 1 x vrata / 2 x polica	72x40x35 72x40x35 72x40x35 72x45x35 72x60x35	514,-		1.055,-	1.074,-		748,- 792,-	748,- 792,-	1.070,- 941,-	1.196,- 1.234,-	661,- 760,-	1.070,- 941,-	1.070,- 941,-
	GS-60-KK L/D 1 x vrata 1 x polica	72x60x60	794,-	805,-	871,-	845,-	983,-	829,-	1.201,-	1.120,-	1.673,-	964,-	1.201,-	1.201,-
	GS-60 2V 2 x vrata 2 x polica	72x60x35	926,-	584,-	656,-	1.045,-	901,-	986,-	1.378,-	1.331,-	1.920,-	855,-	1.378,-	1.378,-
	GS-60/47-N 2V 2 x vrata 1 x polica	47x60x35	821,-	445,-	495,-	975,-	901,-	920,-	1.286,-	1.242,-	1.709,-	523,-	1.286,-	1.286,-
	GS-80-ST/HR 2V GS-80-ST/ALU 2V GS-80-ST 2V GS-90-ST 2V 2 x vrata / 2 x polica	72x80x35 72x80x35 72x80x35 72x90x35	864,-		1.385,-	2.157,-		1.146,- 1.217,-	1.146,- 1.217,-	1.639,- 1.740,-	2.123,- 2.416,-	1.063,- 1.232,-	1.639,- 1.740,-	1.639,- 1.740,-

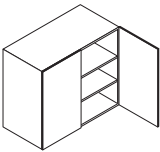
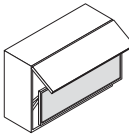
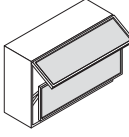
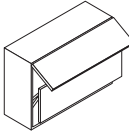
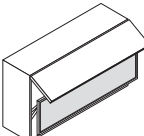
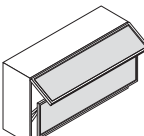
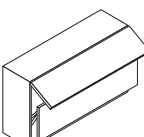
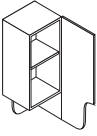
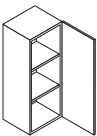
ELEMENTI	OPIS	MJERE	MATEJA	KATARINA	ADRIJANA	KARLA	TEA	EMA	SARA	MIA	NINA	BARBARA	LUCIJA	PETRA
	GS-80 2V	72x80x35	990,-	631,-	718,-	1.096,-	1.034,-	1.057,-	1.511,-	1.384,-	1.860,-	903,-	1.511,-	1.511,-
	GS-90 2V 2 x vrata 2 x polica	72x90x35	1.023,-	671,-	769,-	1.130,-	1.068,-	1.089,-	1.527,-	1.454,-	2.116,-	990,-	1.527,-	1.527,-
	GS-60-PR/ALU 1PV 1STV	72x60x35		2.268,-	2.375,-									
	GS-60-PR/ 1PV 1STV 1 x puna vrata 1 x staklena vrata 1 x polica	72x60x35									2.833,-	2.070,-		
	GS-60-PR/ALU 2STV	72x60x35		2.600,-	2.814,-									
	GS-60-PR/ 2STV 2 x staklena vrata 1 x polica	72x60x35									2.833,-	2.070,-		
	GS-60-PR 2PV 2 x puna vrata 1 x polica	72x60x35		1.808,-	1.908,-						2.833,-	2.070,-		
	GS-80-PR/ALU 1PV 1STV	72x80x35		2.472,-	2.610,-									
	GS-80-PR/ 1PV 1STV	72x80x35									2.944,-	2.160,-		
	GS-90-PR/ALU 1PV 1STV	72x90x35		2.574,-	2.725,-									
	GS-90-PR/ 1PV 1STV 1 x puna vrata 1 x staklena vrata 1 x polica	72x90x35									2.987,-	2.350,-		
	GS-80-PR/ALU 2STV	72x80x35		2.851,-	3.042,-									
	GS-80-PR/ 2STV	72x80x35									2.944,-	2.160,-		
	GS-90-PR/ALU 2STV	72x90x35		2.978,-	3.185,-									
	GS-90-PR/ 2STV 2 x staklena vrata 1 x polica	72x90x35									2.987,-	2.350,-		
	GS-80-PR 2PV	72x80x35		1.965,-	2.088,-						2.944,-	2.160,-		
	GS-90-PR 2PV 2 x puna vrata 1 x polica	72x90x35		2.046,-	2.175,-						2.987,-	2.350,-		
	GVV-30-LV L/D 1 x vrata 1 x polica					1.195,-								
	GVV-30 L/D	96x30x35		535,-	603,-	745,-	700,-	714,-	1.021,-	964,-	1.159,-		1.021,-	
	1 x vrata 2 x polica													

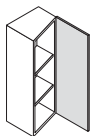
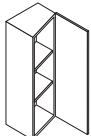
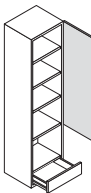
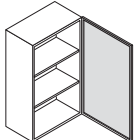
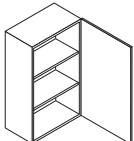
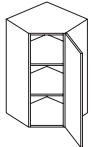
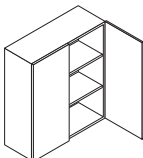
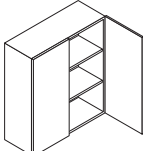
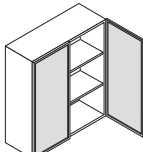
ELEMENTI	OPIS	MJERE	MATEJA	KATARINA	ADRIJANA	KARLA	TEA	EMA	SARA	MIA	NINA	BARBARA	LUCIJA	PETRA
	GVV-35-ZV/ST L/D 1 x vrata 2 x polica	96x35x35				1.102,-	1.102,-		1.406,-		1.785,-		1.406,-	
	GVV-35-ZV/PV L/D 1 x vrata 2 x polica	96x35x35		1.165,-	1.285,-									
	GVV-40-ST/VIT/ALU L/D 1 x vrata 1 x ladica 3 x polica	148x40x35		2.604,-	2.643,-									
	GVV-40-ST/ALU L/D	96x40x35		1.299,-	1.371,-									
	GVV-40-ST L/D	96x40x35				858,-	858,-		1.219,-		1.427,-		1.119,-	
	GVV-45-ST L/D	96x45x35				891,-	891,-		1.270,-		1.511,-		1.270,-	
	GVV-60-ST L/D 1 x vrata 2 x polica	96x60x35				1.251,-	1.251,-		1.788,-		2.133,-		1.788,-	
	GVV-40 L/D	96x40x35		588,-	656,-	831,-	736,-	751,-	1.074,-	1.014,-	1.260,-		1.074,-	
	GVV-45 L/D	96x45x35		615,-	690,-	836,-	751,-	766,-	1.095,-	1.035,-	1.317,-		1.095,-	
	GVV-50 L/D			655,-	733,-									
	GVV-60 L/D 1 x vrata 2 x polica					1.108,-	1.045,-	1.065,-	1.494,-	1.327,-	2.011,-		1.494,-	
	GVV-60 KK 1 x vrata 2 x polica	96x60x60		1.073,-	1.161,-	1.053,-	1.014,-	1.044,-	1.450,-	1.214,-	1.817,-		1.450,-	
	GVV-60 2V 2 x vrata 2 x polica	96x60x35		815,-	914,-	1.227,-	1.205,-	1.228,-	1.756,-	1.509,-	2.152,-		1.756,-	
	GVV-80 2V	96x80x35		884,-	958,-	1.233,-	1.188,-	1.287,-	1.725,-	1.604,-	2.310,-		1.725,-	
	GVV-90 2V 2 x vrata 2 x polica	96x90x35		940,-	1.073,-	1.309,-	1.223,-	1.324,-	1.769,-	1.651,-	2.384,-		1.769,-	
	GVV-80-ST/ALU 2V	96x80x35		2.377,-	2.455,-									
	GVV-80-ST 2V					1.315,-	1.315,-		1.885,-		2.430,-		1.885,-	
	GVV-90 ST 2V 2 x vrata 2 x polica					1.396,-	1.396,-		1.991,-		2.588,-		1.991,-	

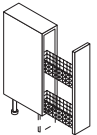
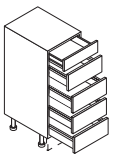
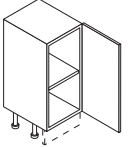
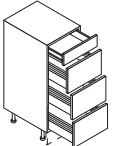
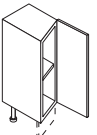
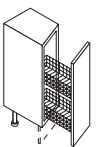
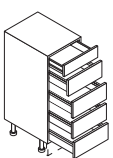
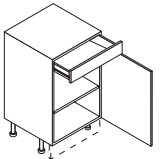
ELEMENTI	OPIS	MJERE	MATEJA	KATARINA	ADRIJANA	KARLA	TEA	EMA	SARA	MIA	NINA	BARBARA	LUCIJA	PETRA
	D-15-IZK	82x15x58	961,-	851,-	791,-	1.097,-	932,-	980,-	1.059,-	1.285,-	1.276,-	1.367,-	1.059,-	1.059,-
	D-20-MBX	82x20x58	1.136,-	858,-	900,-									
	D-20-IZK 1 x vrata 1 x košara					1.242,-	1.306,-	1.148,-	1.393,-	1.595,-	1.681,-	1.404,-	1.393,-	1.393,-
	D-20-LAD/5 5 x ladica	82x20x58	1.357,-											
	D-20/72 L/D	82x20x58		475,-	522,-	688,-	688,-	604,-	799,-	766,-	1.044,-	548,-	799,-	799,-
	D-30/72 L/D 1 x vrata/72 1 x polica	82x30x58	700,-	499,-	546,-	857,-	721,-	804,-	1.006,-	965,-	1.294,-	573,-	1.006,-	1.006,-
	D-30-LAD/4 MBX 1 x ladica plitka 3 x ladica duboka	82x30x58		1.351,-	1.438,-									
	D-35-Z L/D 1 x vrata 1 x polica	82x35x58	1.020,-	743,-	810,-	1.093,-	1.026,-	1.068,-	1.468,-	1.340,-	1.629,-	850,-	1.468,-	1.468,-
	D-35-Z/IZK L/D 1 x vrata 1 x košara	82x35x58	2.499,-			2.060,-	1.934,-	2.013,-	2.685,-	2.525,-	3.070,-		2.685,-	2.685,-
	D-40-LAD/4+1 1 x ladica plitka 4 x ladica duboka	82x40x58	1.652,-											
	D-40 L/D 1LAD	82x40x58		796,-	876,-							920,-		
	D-60 L/D 1LAD 1 x vrata 1 x ladica 1 x polica	82x60x58		1.020,-	1.116,-									

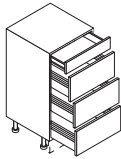
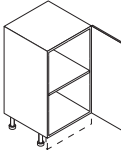
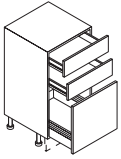
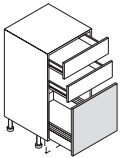
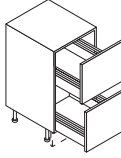
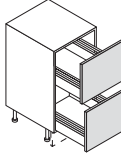
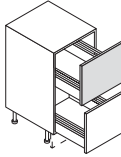
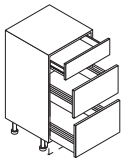
ELEMENTI	OPIS	MJERE	MATEJA	KATARINA	ADRIJANA	KARLA	TEA	EMA	SARA	MIA	NINA	BARBARA	LUCIJA	PETRA
	D-40-LAD/4 INL	82x40x58				2.055,-	1.719,-	1.840,-	2.956,-	2.485,-	3.196,-		2.956,-	2.956,-
	D-40-LAD/4 MBX	82x40x58		1.428,-	1.531,-							1.573,-		
	D-45-LAD/4 INL	82x45x58				2.092,-	1.750,-	1.791,-	3.045,-	2.418,-	3.289,-		3.045,-	3.045,-
	D-45-LAD/4 MBX	82x40x58										1.646,-		
	D-60-LAD/4 INL	82x60x58				2.197,-	1.870,-	1.945,-	3.300,-	2.626,-	3.568,-		3.300,-	3.300,-
	D-60-LAD/4 MBX	82x60x58										1.726,-		
	4 x ladica													
	D-40/72 L/D	82x40x58	724,-	535,-	591,-	886,-	832,-	861,-	1.190,-	1.086,-	1.332,-	607,-	1.190,-	1.190,-
	D-45/72 L/D	82x45x58	767,-	603,-	666,-	937,-	880,-	905,-	1.254,-	1.222,-	1.393,-	680,-	1.254,-	1.254,-
	D-50/72 L/D	82x50x58	895,-	660,-	729,-							813,-		
	D-60/72 L/D	82x60x58	1.186,-	749,-	828,-	1.313,-	1.180,-	1.239,-	1.617,-	1.482,-	2.142,-	850,-	1.617,-	1.617,-
	1 x vrata/72 1 x polica													
	D-40-LAD/1+2 MBX	82x40x58										1.394,-		
	D-40-LAD/1+2 INL	82x40x58				1.758,-	1.301,-	1.550,-	2.530,-	1.827,-	2.783,-		2.530,-	2.530,-
	D-45-LAD/1+2 INL	82x45x58				1.794,-	1.560,-	1.607,-	2.581,-	2.169,-	2.839,-		2.581,-	2.581,-
	D-60-LAD/1+2 INL	82x60x58				1.903,-	1.592,-	1.705,-	2.736,-	2.302,-	3.010,-		2.736,-	2.736,-
	D-60-LAD/1+2 MBX	82x60x58										1.670,-		
	2 x ladica plitka 1 x ladica duboka													
	D-40-LAD/1ST+2 INL	82x40x58						1.662,-	2.656,-	2.244,-	2.922,-		2.656,-	2.656,-
	D-45-LAD/1ST+2 INL	82x45x58						1.695,-	2.715,-	2.288,-	2.981,-		2.715,-	2.715,-
	D-60-LAD/1ST+2 INL	82x60x58						1.799,-	2.915,-	2.428,-	3.160,-		2.915,-	2.915,-
	2 x ladica plitka 1 x staklena ladica duboka													
	D-60-LAD/2 INL	82x60x58				1.883,-	1.438,-	1.510,-	2.613,-	2.039,-	2.749,-		2.613,-	
	D-60-LAD/2 MBX	82x60x58										1.452,-		
	2 x ladica duboka													
	D-60-LAD/2ST INL	82x60x58							2.873,-		3.024,-		2.873,-	2.873,-
	2 x staklena ladica duboka													
	D-60-LAD/1ST+1 INL	82x60x58						1.661,-	2.742,-	2.243,-	2.886,-		2.742,-	2.742,-
		1 x staklena ladica duboka 1 x ladica duboka												
	D-60-LAD/2+1 MBX	82x60x58	1.936,-	1.290,-	1.671,-									
	1 x ladica plitka 2 x ladica duboka													

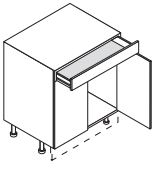
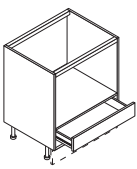
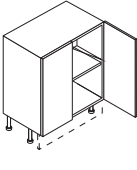
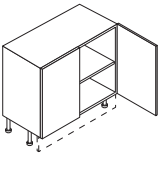
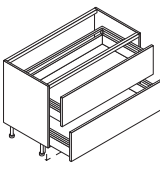
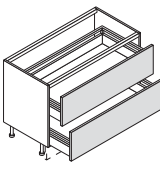
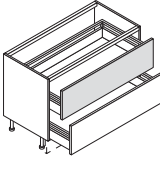
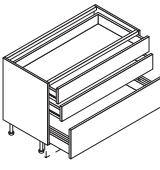
ELEMENTI	OPIS	MJERE	MATEJA	KATARINA	ADRIJANA	KARLA	TEA	EMA	SARA	MIA	NINA	BARBARA	LUCIJA	PETRA
	D-60 2V 1LAD 2 x vrata 1 x ladica	82x60x58		1.205,-	1.418,-									
	D-60-ŠT/LAD/INL 1 x ladica	82x60x58				875,-	822,-	859,-	1.175,-	1.159,-	1.529,-		1.284,-	1.284,-
	D-60-ŠT/LAD/MBX 1 x ladica	82x60x58	716,-	591,-	630,-							712,-		
	D-60/72 2V 2 x vrata 1 x polica	82x60x58	1.228,-	801,-	881,-	1.390,-	1.229,-	1.312,-	1.732,-	1.659,-	2.190,-	925,-	1.667,-	
	D-80/72 2V 2 x vrata/72 1 x polica	82x80x58	1.352,-	868,-	968,-	1.398,-	1.307,-	1.351,-	1.827,-	1.743,-	2.400,-	1.001,-	1.827,-	1.827,-
	D-90/72 2V 2 x vrata/72 1 x polica	82x80x58	1.396,-	936,-	1.045,-	1.493,-	1.355,-	1.409,-	1.937,-	1.902,-	2.507,-	1.093,-	1.907,-	1.907,-
	D-80-LAD/2 MBX 2 x ladica											1.742,-		
	D-80-LAD/2 INL 2 x ladica	82x80x58					1.558,-	1.859,-	3.131,-	2.510,-	3.385,-		3.131,-	
	D-90-LAD/2 INL 2 x ladica	82x90x58					1.558,-	1.989,-	3.349,-	2.684,-	3.620,-		3.349,-	
	D-90-LAD/2 MBX 2 x ladica	82x90x58		1.884,-	2.033,-							2.527,-		
	D-80-LAD/2ST INL 2 x ladica staklena	82x80x58							3.284,-		3.553,-		3.284,-	3.284,-
	D-90-LAD/2ST INL 2 x ladica staklena	82x90x58							3.516,-		3.801,-		3.516,-	3.516,-
	D-80-LAD/1ST+1 INL 1 x staklena ladica 1 x ladica	82x80x58						2.212,-	3.224,-	2.762,-	3.469,-		3.224,-	3.224,-
	D-90-LAD/1ST+1 INL 1 x staklena ladica 1 x ladica	82x90x58						2.187,-	3.449,-	2.952,-	3.729,-		3.449,-	3.449,-
	D-80-LAD/1+2 MBX 2 x ladica plitka 1 x ladica duboka	82x80x58										2.033,-		
	D-80-LAD/1+2 INL 2 x ladica plitka 1 x ladica duboka	82x80x58					1.913,-	1.969,-	3.160,-	2.659,-	3.476,-		3.160,-	3.160,-
	D-90-LAD/1+2 INL 2 x ladica plitka 1 x ladica duboka	82x90x60					1.952,-	2.097,-	3.366,-	2.830,-	3.703,-		3.366,-	3.366,-
	D-90-LAD/1+2 MBX 2 x ladica plitka 1 x ladica duboka	82x90x60										2.759,-		

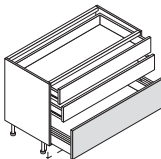
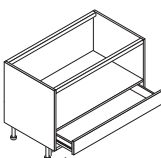
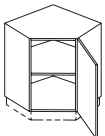
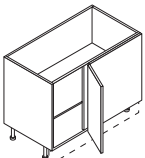
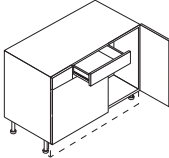
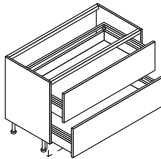
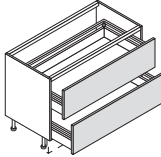
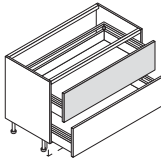
ELEMENTI	OPIS	MJERE	MATEJA	KATARINA	ADRIJANA	KARLA	TEA	EMA	SARA	MIA	NINA	BARBARA	LUCIJA	PETRA
	D-80-LAD/1ST+2 INL	82x80x58						2.077,-	3.270,-	2.804,-	3.650,-		3.270,-	3.270,-
	D-90-LAD/1ST+2 INL	82x90x58						2.011,-	3.575,-	2.987,-	3.887,-		3.575,-	3.575,-
	2 x ladica plitka 1 x staklena ladica duboka													
	D-90-ŠT/LAD/INL	82x90x58				1.265,-	1.132,-	1.174,-	1.524,-	1.584,-	1.843,-		1.524,-	
	1 x ladica													
	D-90-KK L/D	82x90x90	1.254,-	1.123,-	1.481,-	1.535,-	1.441,-	1.478,-	1.552,-	1.995,-	1.924,-	1.293,-	1.552,-	1.552,-
	1 x vrata/72x46 1 x polica													
	D-90/30-K-90 L/D	82x90x90	1.049,-	708,-	765,-	1.284,-	1.096,-	1.132,-	1.312,-	1.528,-	1.676,-	835,-	1.312,-	1.312,-
	D-90/40-K-100 L/D	82x90x90	1.079,-	723,-	786,-	1.321,-	1.128,-	1.201,-	1.379,-	1.621,-	1.766,-	855,-	1.379,-	1.379,-
	D-90/45-K-105 L/D	82x90x90	1.092,-	749,-	819,-	1.335,-	1.199,-	1.247,-	1.419,-	1.684,-	1.817,-	883,-	1.419,-	1.419,-
	1 x vrata/72 1 x polica													
	D-100-MB L/D	82x100x58	1.859,-	1.694,-	1.853,-									
	1 x vrata 40cm 1 x vrata 60cm 1 x ladica 30cm 1 x maska 30 cm													
	D-120-LAD/2 INL	82x120x58						2.345,-	3.949,-	3.166,-	4.270,-		3.949,-	
	2 x ladica													
	D-120-LAD/2ST INL	82x120x58							4.174,-		4.484,-		4.067,-	4.067,-
	2 x staklena ladica													
	D-120-LAD/1ST+1 INL	82x120x58						2.580,-	4.067,-	3.483,-	4.398,-		4.067,-	4.067,-
	1 x staklena ladica 1 x ladica													

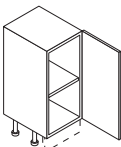
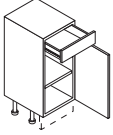
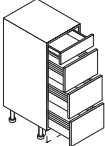
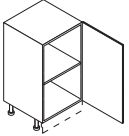
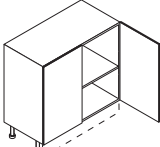
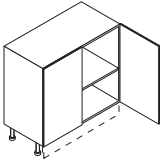
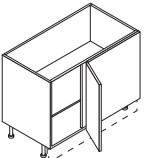

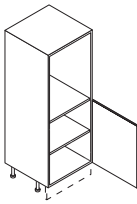
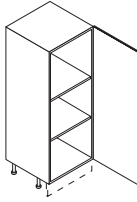
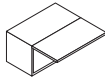
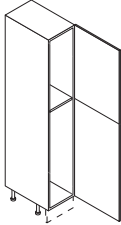
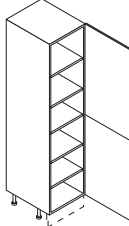
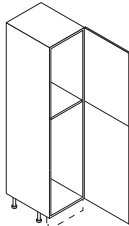
ELEMENTI	OPIS	MJERE	MATEJA	KATARINA	ADRIJANA	KARLA	TEA	EMA	SARA	MIA	NINA	BARBARA	LUCIJA	PETRA
	DŠ-30 L/D 1 x vrata 30x72 cm 1 x maska vrata 30x72 cm 1 x polica	82x30x60	891,-	749,-	819,-	963,-	810,-	906,-	1.147,-	1.082,-	1.455,-	870,-	1.147,-	1.147,-
	DŠ-40 L/D 1 x vrata 40x60 cm 1 x maska vrata 40x72 cm 1 x ladica 1 x polica	82x40x60	1.398,-	803,-	936,-	1.876,-	1.073,-	1.110,-	1.537,-	1.289,-	1.707,-	988,-	1.537,-	1.537,-
	DŠ-40-LAD/3+1 1 x vrata 40x72 cm 1 x ladica plitka 3 x ladica duboka	82x40x60	1.851,-	1.666,-			1.893,-	1.982,-	3.179,-	2.689,-	3.401,-		3.179,-	3.179,-
	DŠ-60/72 1 x vrata 60x72 cm 1 x maska vrata 60x72 cm 1 x polica	82x60x60	1.914,-			1.576,-	1.416,-	1.444,-	2.070,-	1.778,-	2.587,-	1.310,-	2.070,-	
	DŠ-80 2V 2 x vrata 40x72 cm 2 x maska vrata 40x72 cm 1 x polica	82x80x60	2.542,-	1.193,-	1.330,-	2.646,-	1.730,-	1.778,-	2.495,-	2.389,-	3.174,-	1.690,-	2.495,-	2.495,-
	DŠ-90 2V 2 x vrata 45x72 cm 2 x maska vrata 45x72 cm 1 x polica	82x90x60		1.226,-	1.381,-	1.993,-	1.809,-	1.849,-	2.699,-	2.539,-	3.371,-		2.699,-	2.699,-
	DŠ-120-K/L/D 1 x vrata 60x72 cm 3 x maska vrata 40x72 cm 1 x polica	82x120x60	2.564,-	1.353,-	1.530,-	2.959,-	1.990,-	2.085,-	2.922,-	2.756,-	3.649,-		2.922,-	2.922,-

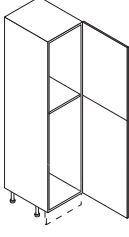
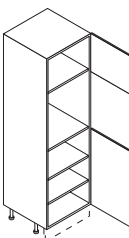
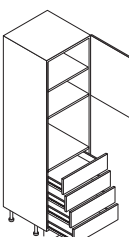
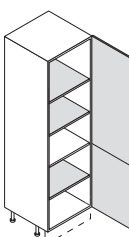
ELEMENTI	OPIS	MJERE	MATEJA	KATARINA	ADRIJANA	KARLA	TEA	EMA	SARA	MIA	NINA	BARBARA	LUCIJA	PETRA
	DV-60/68/P L/D	138x60x58		1.109,-	1.278,-	1.333,-	1.182,-	1.258,-	1.802,-	1.707,-	2.196,-	1.345,-	1.802,-	1.802,-
	DV-60/72/P L/D	144x60x58	1.650,-											
	1 x vrata 1 x polica													
	DV-60/128 L/D	138x60x58	2.332,-	1.150,-	1.329,-	1.555,-	1.379,-	1.462,-	1.942,-	1.991,-	2.472,-	1.345,-	1.942,-	1.942,-
	1 x vrata 2 x polica													
	VJN-40/24	24x40x58			563,-	520,-	433,-	500,-	627,-	602,-	873,-		627,-	
	VJN-60/24	24x60x58		591,-	634,-	574,-	479,-	552,-	693,-	666,-	965,-	605,-	693,-	693,-
	1 x vrata podizna													
	VJ-30/128/72 L/D	210x30x58				1.790,-	1.635,-	1.689,-	2.387,-	2.275,-	3.116,-		2.387,-	
	2 x vrata													
	VJ-40/100/100 L/D	210x40x58		1.693,-	1.863,-									
	2 x vrata 4 x polica													
	VJ-40/128/72 L/D					1.892,-	1.728,-	1.785,-	2.523,-	2.407,-	3.280,-		2.523,-	
	2 x vrata													

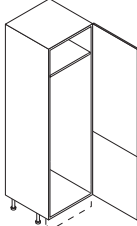
ELEMENTI	OPIS	MJERE	MATEJA	KATARINA	ADRIJANA	KARLA	TEA	EMA	SARA	MIA	NINA	BARBARA	LUCIJA	PETRA
	VJ-45/72-ST/128-ST L/D 2 x staklena vrata	210x45x58							2.774,-		3.606,-		2.774,-	
	VJ-45/128/72 L/D 2 x vrata	210x60x58				1.992,-	1.818,-	1.879,-	2.675,-	2.550,-	3.477,-		2.675,-	
	VJ-60/57/P/MW/36 L/D 1 x vrata 57 cm 1 x vrata 36 cm 1 x polica	210x60x58			1.849,-	1.679,-	1.489,-	1.584,-	2.334,-	2.150,-	2.944,-	2.214,-	2.334,-	2.334,-
	VJ-60/100/P/40 L/D 1 x vrata 100 1 x vrata 40 2 x polica	210x60x58	2.090,-	1.853,-	2.030,-	3.319,-	2.090,-	2.703,-	2.775,-	3.649,-	3.619,-	2.214,-	2.775,-	2.775,-
	VJ-60/72-LAD/P/68 L/D 4 x ladica 1 x vrata 68 1 x polica	210x60x58				3.942,-		3.350,-	3.292,-		4.266,-		3.292,-	
	VJ-60/72-ST/128-ST/VIT 1 x vrata 72 1 x vrata 128 3 x staklena polica	210x60x58					3.786,-							

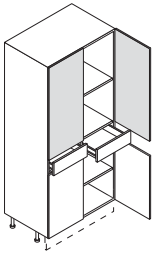
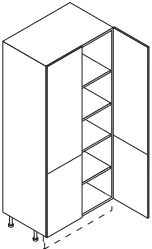
ELEMENTI	OPIS	MJERE	MATEJA	KATARINA	ADRIJANA	KARLA	TEA	EMA	SARA	MIA	NINA	BARBARA	LUCIJA	PETRA
	VJ-60/72/128 L/D 1 x vrata 72 cm 1 x vrata 128 cm	210x60x58	2.332,-	1.853,-	2.063,-	2.222,-	1.970,-	2.096,-	2.984,-	2.845,-	3.895,-	1.992,-	2.984,-	2.984,-
	VJ-60/88/40/72 L/D 1 x vrata 88 1 x vrata 40 1 x vrata 72 1 x polica	210x60x58	2.618,-	2.040,-	2.260,-									
	VJ-60/100/100 L/D 2 x vrata 100 2 x polica	210x60x60	2.332,-	1.853,-	2.063,-	2.222,-	1.970,-	2.096,-	2.984,-	2.845,-	3.895,-	1.992,-	2.984,-	2.984,-
	VJ-60/110/90 L/D 1 x vrata 110 1 x vrata 90 2 x polica	210x60x58	2.332,-	1.853,-	2.063,-	2.222,-	1.970,-	2.096,-	2.984,-	2.845,-	3.895,-	1.992,-	2.984,-	2.984,-
	VJ-60/123/40/35 L/D 1 x vrata 123 1 x vrata 40 1 x vrata 35	210x60x58	2.618,-	2.040,-	2.260,-	2.334,-	2.069,-	2.201,-	3.134,-	2.988,-	4.045,-	2.214,-	3.134,-	3.134,-
	VJ-60/128/72 L/D 1 x vrata 128 1 x vrata 72 1 x polica	210x60x58	2.332,-	1.853,-	2.063,-	2.222,-	1.970,-	2.096,-	2.984,-	2.845,-	3.895,-	1.992,-	2.984,-	2.984,-

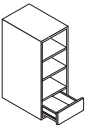
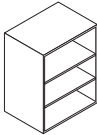
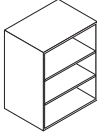
ELEMENTI	OPIS	MJERE	MATEJA	KATARINA	ADRIJANA	KARLA	TEA	EMA	SARA	MIA	NINA	BARBARA	LUCIJA	PETRA
	VJ-80/72/2 LAD/115 2ST 2 x vrata 72 2 x ladica 2 x staklena vrata 115	210x80x58					4.388,-							
	VJ-90/72-ST/128-ST 2 x vrata 72 2 x vrata 128 3 x polica	210x80x58							4.652,-		6.048,-		4.652,-	

	OPIS	MJERE	MATEJA	KATARINA	ADRIJANA	KARLA	TEA	EMA	SARA	MIA	NINA	BARBARA	LUCIJA	PETRA
	GS-20-OF 1LAD 1 x ladica 2 x polica	72x20x35	752,-											
	GS-15-OF	72x15x35				507,-	507,-	507,-	507,-	602,-	602,-		507,-	507,-
	GS-20-OF	72x20x35				568,-	568,-	568,-	568,-	618,-	618,-		568,-	568,-
	GS-30-OF	72x30x35				667,-	667,-	667,-	667,-	634,-	634,-		667,-	667,-
	GS-50-OF 2 x polica	72x50x35				833,-	833,-	833,-	833,-	875,-	875,-		833,-	833,-
	GS-15-OPL	72x15x35	271,-	271,-	271,-							271,-		
	GS-20-OPL	72x20x35	286,-	286,-	286,-							286,-		
	GS-30-OPL	72x30x35	320,-	320,-	320,-							320,-		
	GS-50-OPL 2 x polica	72x50x35	398,-	398,-	398,-							398,-		
	VTA-PS	45x60	352,-	233,-	256,-	374,-	355,-	254,-	353,-	343,-	454,-	262,-	353,-	353,-
	VTA-PS	45x72	374,-	258,-	284,-	397,-	427,-	277,-	425,-	374,-	546,-	312,-	425,-	425,-
	VTA-PS	60x60	394,-	275,-	303,-	418,-	474,-	328,-	471,-	442,-	606,-	349,-	471,-	471,-
	VTA-PS	60x72	462,-	300,-	330,-	490,-	570,-	370,-	565,-	499,-	727,-	418,-	565,-	565,-
	MASKA	96x10x1.8		105,-	105,-	184,-	248,-	149,-		184,-			149,-	
	MASKA	72x10x1.8		80,-	80,-	127,-	171,-	111,-		127,-			111,-	

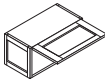
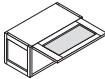
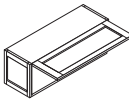
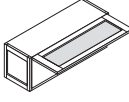
ELEMENTI	OPIS	MJERE	DOMINOO
	GN-49-OTK	36x49x35	1.412,-
	GN-69-OTK	36x69x35	1.639,-
	GN-74-OTK	36x74x35	1.716,-
	1 x vrata		
	GN-49-ST/OTK	36x49x35	1.392,-
	GN-69-ST/OTK	36x69x35	1.562,-
	GN-74-ST/OTK	36x74x35	1.639,-
	1 x vrata staklena		
	GN-89-OTK	36x89x35	1.949,-
	GN-139-OTK	36x139x35	2.648,-
	1 x vrata		
	GN-89-ST/OTK	36x89x35	1.859,-
	GN-139-ST/OTK	36x139x35	2.475,-
	1 x vrata staklena		

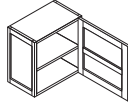
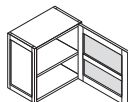
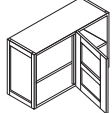
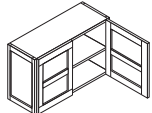
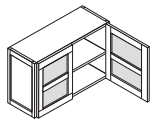

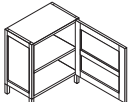
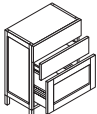
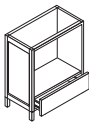
ELEMENTI	OPIS	MJERE	DOMINOO
	GS-49 L/D	72x49x35	2.013,-
	GS-60 L/D	72x60x35	2.399,-
	GS-69 L/D	72x69x35	2.613,-
	GS-74 L/D	72x74x35	2.715,-
	GS-89 L/D	72x89x35	4.278,-
	1 x vrata 1 x polica		
	GS-49-ST L/D	72x49x35	1.936,-
	GS-69-ST L/D	72x69x35	2.626,-
	GS-74-ST L/D	72x74x35	2.542,-
	GS-89-ST L/D	72x89x35	3.962,-
	1 x vrata staklena 1 x polica		
	GS-95-K L/D	72x95x35	3.122,-
	GS-103/60-K L/D	72x103x35	3.262,-
	1 x vrata 1 x polica		
	GS-139 2V	72x139x35	4.475,-
	2 x vrata 1 x polica		
	GS-139-ST 2V	72x139x35	4.179,-
	2 x vrata staklena 1 x polica		

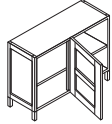
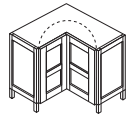
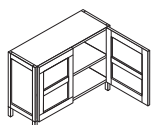
ELEMENTI	OPIS	MJERE	DOMINOO
	D-49 L/D	87x49x58	2.977,-
	D-69 L/D	87x69x58	3.501,-
	D-74 L/D	87x74x58	3.639,-
	1 x vrata 1 x polica		
	D-49-LAD/1+2	87x49x58	4.278,-
	D-74-LAD/1+2	87x74x58	4.567,-
	D-89-LAD/1+2 DLX	87x89x58	4.866,-
	1 x ladica duboka 2 x ladica plitka		
	D-69-ŠT/LAD DLX	87x69x58	3.098,-
	1 x ladica		

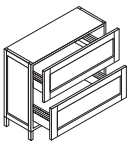
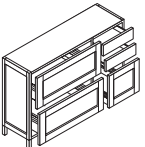
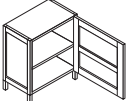
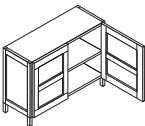
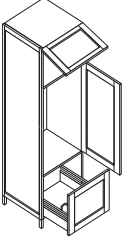

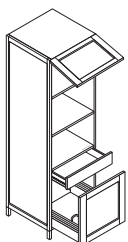
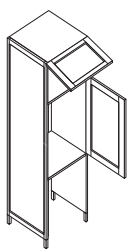
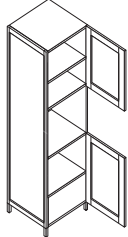
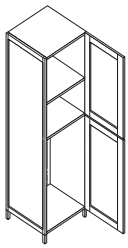
ELEMENTI	OPIS	MJERE	DOMINOO
	D-94/40-K L/D	87x94x58	3.797,-
	1 x vrata 1 x polica		
	D-95-KK/OKR	87x95x95	6.794,-
	2 x vrata/72 1 x okretna polica		
	D-89 2V	87x89x58	4.659,-
	D-139 2V	87x139x58	5.471,-
	2 x vrata/72 1 x polica		

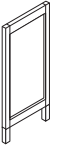



ELEMENTI	OPIS	MJERE	DOMINOO
	D-69-LAD/2 DLX	87x69x58	3.859,-
	D-89-LAD/2 DLX	87x89x58	4.759,-
	D-139-LAD/2	87x139x58	6.557,-
	2 x ladica		
	D-139-LAD/3+2	87x139x58	7.730,-
	3 x ladica duboka 2 x ladica plitka		
	DŠ-49 L/D	87x49x58	3.630,-
	DŠ-69 L/D	87x69x58	4.457,-
	DŠ-74 L/D	87x74x58	4.672,-
	1 x vrata 60cm 1 x vrata 72cm 1 x ladica 1 x polica		
	DŠ-129-K L/D	87x129x58	7.533,-
	2 x vrata 60x30 1 x vrata 60x72 1 x ladica		
	VJ-69/36-LAD/125/36 L/D	210,5x69x58	8.460,-
	1 x ladica 1 x vrata 125 1 x vrata 36		



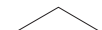

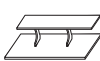

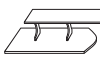
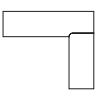

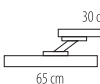
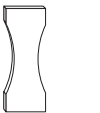
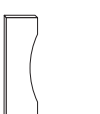

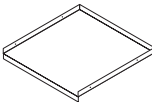
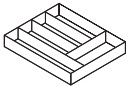

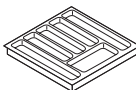

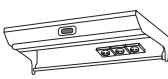
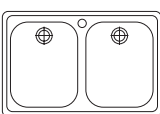
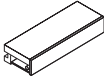
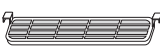
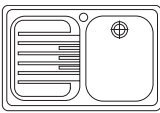

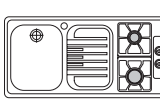



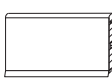
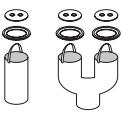
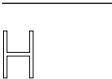
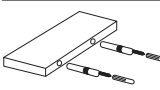





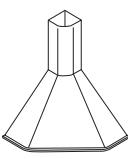
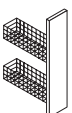

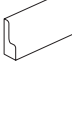
ELEMENTI	OPIS	MJERE	DOMINOO
	VJ-69/36-LAD/P/MW/36	210,5x69x58	7.072,-
	1 x ladica duboka 1 x ladica plitka 1 x vrata 36		
	VJ-69/PS/91/36 L	210,5x69x58	6.588,-
	1 x vrata 91 1 x vrata 36		
	VJ-69/72/P/65 L	210,5x69x58	6.420,-
	1 x vrata 72 1 x vrata 65 2 x polica		
	VJ-69/125-HL/72 L	210,5x69x58	7.259,-
	1 x vrata 125 1 x vrata 72 1 x polica		

ELEMENTI	OPIS	MJERE	DOMINOO
	STRANICA D	87x58x4,5	722,-
	VRATA PS	71,5x44,6	717,-
	VRATA PS	71,5x59,6	958,-

ELEMENTI	OPIS	MJERE	DOMINOO
	Strop. polica 350x19 fur. hr.	35x1,9	219,-
	Strop. polica 350x29 fur. hr.	35x2,9	249,-
	Strop. polica 350x39 fur. hr.	35x3,9	279,-
	max. dužina 240 cm		

ELEMENTI	OPIS	JM	CIJENA
	ZAJED. PLOČA S RUB. LET. RAVNOM		
	ZP RLH CORAL	m	520,-
	ZP RLH INDIJSKI MR.	m	520,-
	ZP RLH BEŽ	m	520,-
	ZP RLH BIJELA	m	520,-
	ZP B. 600 ZA RL ALU 70	m	498,-
	ZP B. 1200 ZA RL ALU 70	m	821,-
	ZP B. 600 ZA RL ALU 42	m	498,-
	ZP B. 1200 ZA RL ALU 42	m	821,-
	ZAJEDNIČKA RADNA PLOČA		
	ZP RAZ. DIM. RLH-CORAL	m ²	925,-
	ZP RAZ. DIM. RLH -IND.MR.	m ²	925,-
	ZP RAZ. DIM. RLH-BEŽ	m ²	925,-
	ZP RAZ. DIM. RLH-BIJELA	m ²	925,-
	ZAJED. PL. S RUB. LET. KOS./ZAOB.		
	Kosa//CORAL 991405	m	630,-
	Kosa//IND. MR. 991104	m	630,-
	Zaob//IND. MR. 991105	m	630,-
	Kosa//BIJELA 991505	m	630,-
	Kosa//BEŽ 991205	m	630,-
	Z. PLOČA RUBNA LETVA		
	Zaobljena//CORAL 991404	m	630,-
	Zaobljena//CORAL 991404	m	630,-
	Zaobljena//BEŽ 991204	m	630,-
	Z. RADNA P. POSTFORMING		
	BUKVA	m	365,-
	GRANIT ZELEN	m	365,-
	BAMBUS	m	365,-
max duž. 4,10 m	MRAMOR SALOME	m	365,-
	KAMEN BIJELI	m	365,-
	BIJELA 600 mm	m	365,-
	BIJELA 900 mm	m	365,-
	Z. RADNA PLOČA KUTNA		
101,5x101,5 90x90	ZP K CORAL 991407	kom	885,-
	ZP K BEŽ 991207	kom	885,-
	ZP K IND. MR. 991107	kom	885,-
	ZP K BIJELA 991507	kom	885,-
	ZP KK BIJELA 992318	kom	1.200,-
	ZP KK CARRARA 992311	kom	1.200,-
	ZP KK GRANIT ZEL. 992312	kom	1.200,-
	ZP KK TREŠNJA 992313	kom	1.200,-
	ZP KK BUKVA 992304	kom	1.200,-
	ZP KK CORAL 992307	kom	1.200,-
	ZP KK IND. MR. 992301	kom	1.200,-
	ZPŠ D. RLH CORAL 630	m	715,-
	ZPŠ D. RLH BIJELA 630	m	715,-
	ZPŠ D. RLH IND.MR. 630	m	715,-
	ZPŠ DONJA RLH BEŽ 630	m	715,-

ELEMENTI	OPIS	JM	CIJENA
	ZPŠ G. RLH CORAL 300	m	500,-
	ZPŠ G. RLH BIJELA 300	m	500,-
	ZPŠ G. RLH IND. MR. 300	m	500,-
	ZPŠ GORNJA RLH BEŽ 300	m	500,-
	ZPŠ RLH CORAL D+G	m	1.250,-
	ZPŠ RLH BIJELA D+G	m	1.250,-
max duž. 2,70 m	ZPŠ RLH IND. MR. D+G	m	1.250,-
	ZPŠ RLH BEŽ D + G	m	1.250,-
	ZPOŠ DONJA RLH CORAL 630	m	1.096,-
	ZPOŠ D. RLH BIJELA 630	m	1.096,-
	ZPOŠ D. RLH IND.MR. 630	m	1.096,-
	ZPOŠ D. RLH BEŽ 630	m	1.096,-
	ZPOŠ GORNJA RLH CORAL 300	m	832,-
	ZPOŠ G. RLH BIJELA 300	m	832,-
	ZPOŠ G. RLH IND.MR. 300	m	832,-
	ZPOŠ G. RLH 300	m	832,-
	ZPOŠ RLH CORAL D+G	m	1.928,-
	ZPOŠ RLH BIJELA D+G	m	1.928,-
	ZPOŠ RLH IND. MR. D+G	m	1.928,-
	ZPOŠ RLH BEŽ D+G	m	1.928,-
	IZRADA KUTNOG SPOJA	kom	363,-
	ZPŠ PF G. IND.MR. 300	m	295,-
	ZPŠ PF GORNJA BUKVA 300	m	295,-
	ZPŠ PF G. TREŠNJA 300	m	295,-
	ZPŠ PF DONJA IND.MR. 650	m	425,-
	ZPŠ PF DONJA BUKVA 650	m	425,-
	ZPŠ PF DONJA TREŠNJA 650	m	425,-
	ZPŠ PF IND. MRAMOR D+G	m	720,-
	ZPŠ PF BUKVA D+G	m	720,-
	ZPŠ PF TREŠNJA D+G	m	720,-
	NOGICA ŠANKA	kom	87,-
	POLUNOGICA ŠANKA	kom	48,-
			48,-
			48,-

ELEMENTI	OPIS	MJERE	J. MJ.	CIJENA	ELEMENTI	OPIS	MJERE	J. MJ.	CIJENA	
	ALU-folija za sudoper					Razdjelnik ALU s pret. za lad.	30	set	225,-	
	D-40 cm ALU		kom	29,-		Razdjelnik ALU s pret. za lad.	40	set	294,-	
	D-45 cm ALU		kom	30,-		Razdjelnik ALU s pret. za lad.	50	set	350,-	
	D-60 cm ALU		kom	36,-						
	D-80 cm ALU		kom	42,-						
	D-90 cm ALU		kom	47,-						
	Korito rosfraj 40 cm ugradno	38x44	kom	238,-		Uložak za ladice PVC 40 cm		kom	30,-	
	Korito rosfraj 45 cm ugradno okruglo	Ø45	kom	250,-		Neonsko svjetlo s utičnicom i satom 90 cm		kom	1.097,-	
	Korito rosfraj dvodjelno nasadno	80x60	kom	370,-		Svjetleća polica na zid	120x20	kom	750,-	
	Korito rosfraj dvodjelno ugradno	81x51	kom	450,-			PVC ozraka za hlad.-četvrt.		kom	10,-
	Korito rosfraj jednostjelno nasadno 80 cm L/D	80x60	kom	300,-		PVC ozraka za hlad.-okrugla		kom	10,-	
	Korito rosfraj jednostjelno ugradno 81 cm L/D	81x51	kom	375,-		ALU lajsne za radne ploče		m	18,-	
	Rosfraj blok 100 cm s plinskim kuhlalom L/D nasadni	100x60	kom	1.125,-		ALU lajsne za radne ploče 1,2 ili 4 metra		m	28,-	
	Rosfraj blok 100 cm s električnim kuhlalom L/D nasadni	100x60	kom	850,-		Metalni "T" profil za kut		kom	38,-	
	ELEKTRIČNO KUHALO dvije ploče		kom	550,-		Metalni profil za vješanje gornjih elemenata MPV_250		kom	38,-	
	Sifon jednostjelni		kom	37,-		PVC podna maska ALU 10		m	24,-	
	Sifon dvodjelni		kom	50,-		PVC podna maska ALU 15		m	29,-	
	Nosač polica skriveni		kom	55,-		Ravni spoj za PM 10 cm ALU		kom	8,-	
	Nosač staklenih polica		par	60,-		Ravni spoj za PM 15 cm ALU		kom	10,-	
	Konzole za šank kr-mat rav.	23/5	kom	238,-		Kutni spoj za PM 10 cm ALU		kom	12,-	
	Konzole za šank kr-mat kos.	23/5	kom	338,-		Kutni spoj za PM 15 cm ALU		kom	14,-	
	Koš za smeće PVC		kom	125,-		KUTNA KUHINJSKA NAPA Polica supernova 2X IX - 100 za napu		kom	3.800,-	
	Koš za smeće Inox eco		kom	1.125,-		IZV ok. za VJ-30-40 sa 6 koš.		GRT	1.880,-	
						IZV ok. za DV-30-40 sa 3 koš.		GRT	1.370,-	
						IZV ok. za D-35/Z sa 2 košare		GRT	540,-	
						Polukr. okretne police za kut		GRT	220,-	
						Kružne okr. police za kosi kut		GRT	350,-	
						ALU PROF. ZA RP 70mm-satin		M	119,-	
						ZAVRŠETAK ALU PROFILA RP		P	288,-	
						V. KUT ZA ALU PROF. RP L/D		K	122,-	
						U. KUT ZA ALU PROF. RP-satin		K	119,-	
						ALU PROFIL ZA RP 42 -satin		M	65,-	
						V. KUT ZA ALU PROF. RP. L/D		K	115,-	
						ZAVRŠETAK ALU PROFILA RP		P	260,-	

UZORCI RUČKICA

702701 2419. MC. 0256			702699 2576. MC. 0320
702700 2523. MC. 160/192			702172 2529/192 MN
702525 UN 9006/128			702000 RE 1107/128
702703 2168. MN. 0128		702695 2276. ANM. 0028	
702697 2288. BR. 0096			702694 2113. MC. 1028
702696 2287. I. 2290		702098 - drvena kapica 702099 - metalna kapica	
702698 2232. ANM. 0128			702237 ALU 126/96
702702 2332. ANM. 0128		702209 GW 0105	

LEGENDA

MC	- mat crom	ANM	- antik niki mat
MN	- mat niki	BR	- bronca

UZORCI BOJA FRONTI KUHINJA

				
DCLT 1238	Zelena	Siva	Tamno plava	La cato corda
				
Bordo	DCLT 1242	DCLT 1215	Slonova kost	Crno/bijela patina

NAPOMENA

Uzorci boja fronti kuhinja vrijede za masivne i furnirane fronte u hrastu i jasenu.

I. GRUPA



Certisa patinirana



Certisa



Tena



Ana



II. GRUPA



Tea



Mateja



Karla



Petra



Sara



Nina



Ema



Mia



Sara



Nina



Lucija

KATARINA



Plava



Bež



Naranča



Wenge



Bordo



Limun



Trešnja natur



Zelena



Izbijeljeni hrast



Cappuccino

ADRIJANA

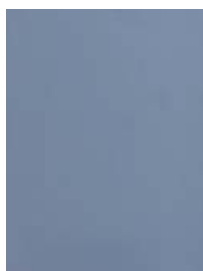

Plava visoki sjaj



Crvena visoki sjaj



Jabuka visoki sjaj



Limun visoki sjaj

BARBARA

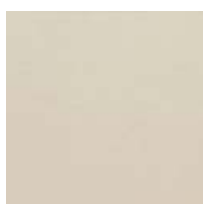

Vanilija



Trešnja

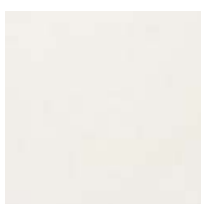

Bijela

DOMINOO



Dominoo

UZORCI RADNIH PLOČA



PF Trešnja

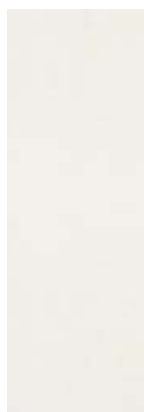

PF Bijela



PF Bukva



PF Syp
hrast



PF Africa



PF Balota



PF Granit
zeleni



PF Indijski
mramor

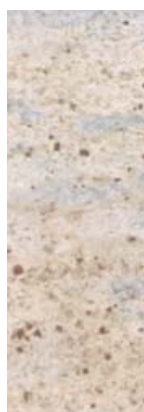

PF Kašmir

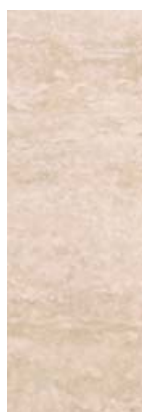

PF Paros



PF Salome



PF Coral



PF Carrara



PF Kamen
bijeli

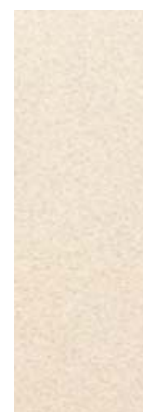

PF Bambus

I. II. GRUPA

UZORCI BOJA KORPUSA

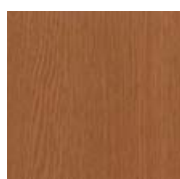

Hrast



Vanilija

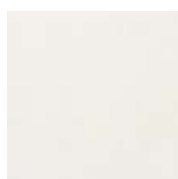

Bijela

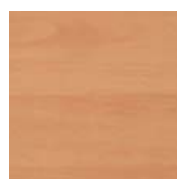

Bukva



Trešnja

NAPOMENA

Kod I. GRUPE kuhinja promjena standardnog korpusa (hrast/bijela) se naplaćuje dodatnih 5%.



TEA - Ambijentalni showroom Peter van Dongen



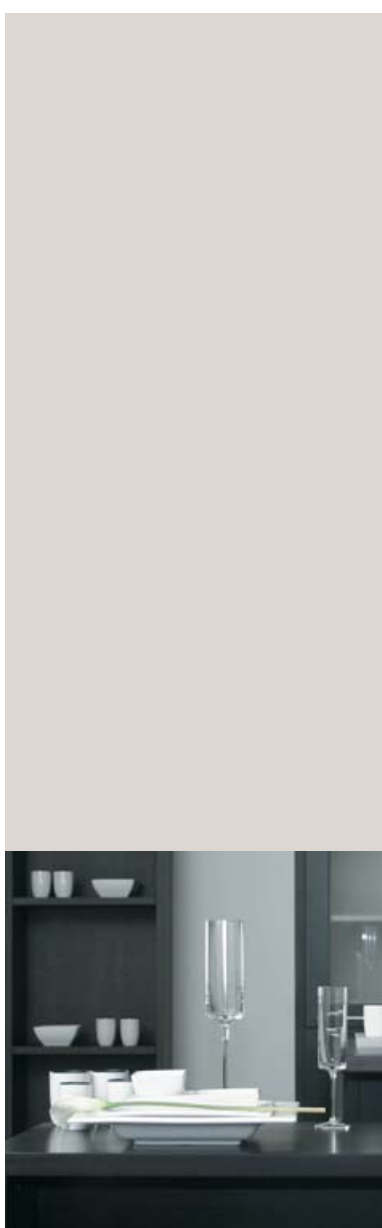

Photo&Design: Alič&Vidić d.o.o.

DRVNA INDUSTRIJA GELI d.o.o.
Petra Preradovića 221, 31400 Đakovo
Tel.: +385 (0)31 840 030 , Fax: +385 (0)31 840 026
prodaja@geli.hr

www.geli.hr